

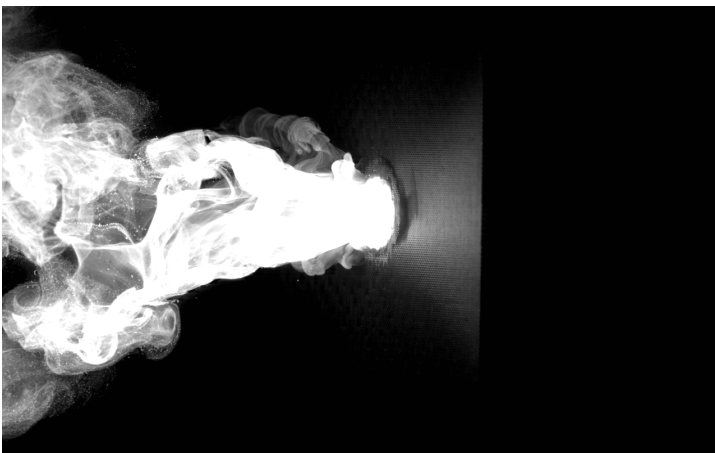

ANNUAL REPORT
2017/2018



The picture shows the formation of a vapor cloud in a laser-irradiated sample made of carbon-fiber-reinforced plastic and was recorded with a high-speed camera. The interaction of intense laser radiation with matter involves numerous physical and chemical processes that occur on different time scales. While, for example, thermal conduction processes take place on a time scale of seconds and can be observed with comparatively slow cameras, the formation of the vapor and plasma cloud is characterized by high dynamics on a scale of microseconds. For the visualization of such fast processes, a special high-speed measurement technology is required.

ANNUAL REPORT
2017/2018

"OPPORTUNITIES FOR NEW RESEARCH"

Dear readers,

Novelty demands space – and new research topics require big space. After two years of construction, we were able to inaugurate our new building on November 13, 2017. Excellent organization and planning by our Munich headquarters and at EMI, as well as a little bit of luck, allowed us to complete this project well within time and budget.

The new construction attaches seamlessly to the existing building. A two-story bridge with offices, laboratories and a library connects the two. This connecting element shortens paths and furthers the flow of information exchange. It is a bridge to the new at EMI as well as to the University of Freiburg surrounding our institute.

The new at EMI manifests itself, for example, in the Laboratory for Multi-Material Design. A split Hopkinson tension bar with the possibility to test strain rates as low as 100 1/s is uncharted territory. Yet, precisely this low loading velocity is the challenge. It cannot be achieved at standard Hopkinson bars as pulse durations are too short and the required samples too large. Servo-hydraulic systems, however, show excessive oscillations in the measurement signal exactly within this range that is so important for crash applications in the automotive industry. Accordingly, the new facility at EMI met great interest at the 8th *crashMAT* Workshop in Freiburg.

The influence of production parameters on mechanical properties of materials is one of the major topics in materials research. Additive manufacturing, also known as laser melting or 3D printing, is becoming an ever more relevant production process. Two metal 3D printers in the new building provide EMI with options to transfer digital design and simulation results directly to production and to examine material properties of additively manufactured components in detail.

Lasers are gaining importance as military effectors. The observable entry of laser systems of various performance classes onto the battle field requires in-depth research on their potential in both classical EMI topics: armor and anti-armor. The institute is well prepared for this development and has gained experimental experience through the years as well as numerical competence regarding the physics of laser-material interaction. With this expertise, the institute supports and consults the Federal Ministry of Defence (BMVg) in all matters concerning research on laser impact.

In the new Satellite Lab, EMI is making great progress towards entering the orbit. With ERNST, EMI develops a versatile nanosatellite and gathers valuable experience in the fields of sensor technology and communication by means of space-based systems.

The institute itself has already entered another orbital level. Engagement of EMI researchers in teaching, mainly, but not only, at the Faculty of Engineering of the University of Freiburg, is diverse and intensive. For EMI employees, this results not only in opportunities for personal academic development, but also in identifying and recruiting junior scientists. Consequently, the institute profits in many ways when we actively reach out by offering academic teaching and continuing education.

I wish you an inspiring read!

Sincerely yours,



Prof. Dr.-Ing. habil. Stefan Hiermaier
Director Fraunhofer EMI





22

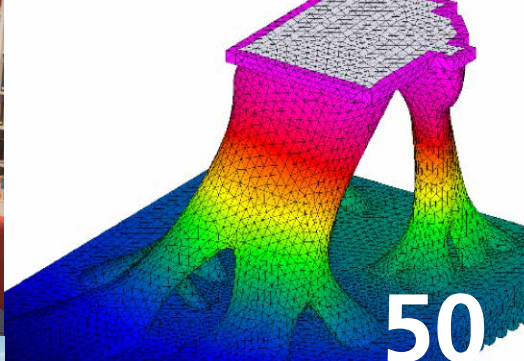

50



48



30

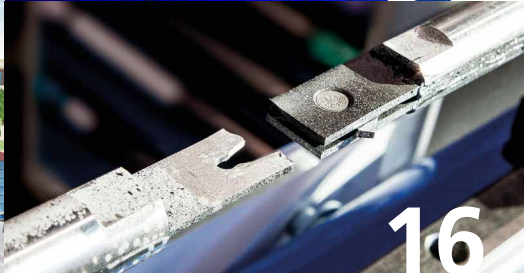

16



68

7 Business unit Defense

- 10 From security research to meteorite impact: research capabilities in the new high-power laser lab
- 12 Modeling the laser irradiation of energetic materials
- 16 Development of new testing methods for the dynamic characterization of hybrid joints in our new laboratory for multi-material design
- 17 EMI-developed tools as standard software used by the Bundeswehr for risk analyses of ammunition storage
- 18 Development of new interior ballistics codes
- 19 Automated X-ray-CT analysis of explosives – cavity search in the 3D microworld
- 20 Functional lightweight design via multi-material construction in 3D printing: new potentials for active and adaptive armor and effect mechanisms and lightweight design
- 22 Expert interview on European defense research with Dr. Stephanie Günther and Professor Klaus Thoma

27 Business unit Security

- 30 Software solution for the analysis of the effects of explosive weapons in populated regions
- 32 Advancement of a tool for the assessment of the resilience of critical infrastructure and integration into a web platform
- 33 The new Sensor Lab at EMI

35 Business unit Automotive

- 38 X-ray diagnostics in crash tests picks up speed
- 40 Upgrade of measurement technology at the Crash Center
- 41 Strain-rate effects caused by failure of battery cells
- 42 Human models instead of dummies – new methods of occupant protection in crash simulations
- 43 Data analysis for objective suitability assessment of hybrid material systems in crash-loaded vehicle structures

45 Business unit Space

- 48 D-MEN: extraction of material samples from asteroids
- 50 Thermal analysis for satellites exemplified by ERNST
- 51 Measurement of ejecta characteristics and impulse transfer in experiments on asteroid deflection

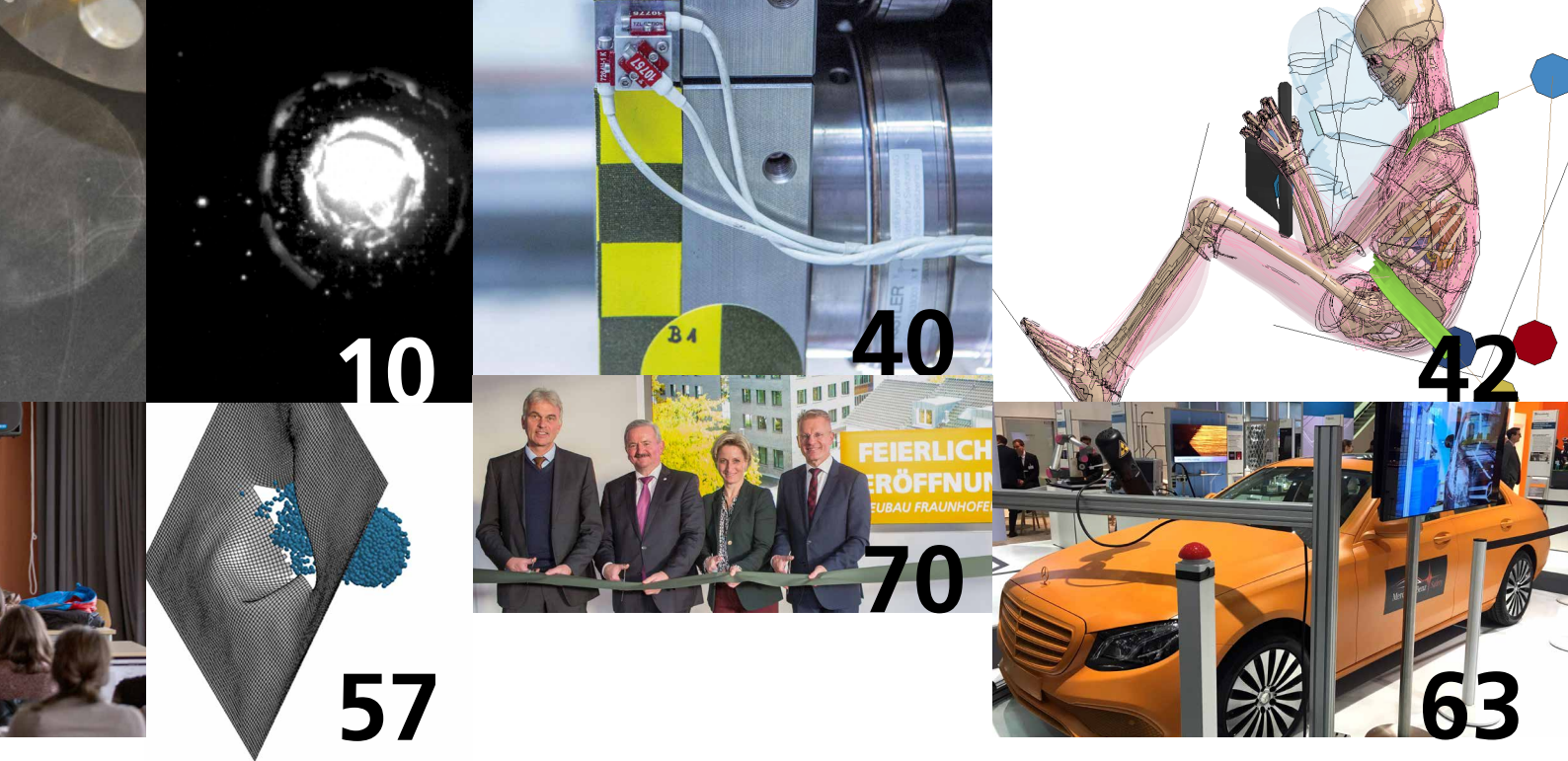

53 Business unit Aviation

- 56 Bird-strike simulations for the new high-speed helicopter "Racer"
- 58 Drone strike: examination of aircraft safety during collisions with unmanned aerial vehicles
- 59 Ice impact on aircraft structures

61 Sustainability Center Freiburg

- 63 Hannover, Los Angeles, New York and Munich: Sustainability Center Freiburg presents latest insights around the world
- 64 Bio-inspired, self-healing materials for a sustainable development
- 65 TAURUS – transatlantic progress in urban resilience research

67 EMI Mosaic

- 68 Applying science and sharing expertise – EMI scientists talk about teaching at INATECH
- 71 More space for applied research in the fields of aviation, space, car crash, defense and security research

73 Profile of the institute

- 74 Contact Persons
- 76 Facts and Figures
- 78 Advisory Board
- 80 Fraunhofer-Gesellschaft

83 Publications, Educational Activities, Scientific Exchange 2017/2018

94 Publishing Notes

BUSINESS UNIT
DEFENSE



BUSINESS UNIT DEFENSE



The expectations towards the capabilities of the Bundeswehr (German Federal Armed Forces) are related to the perception of security in our democratic society. Today, the conditions for this are subject to major changes, especially with respect to technological developments.

In its central business unit Defense, Fraunhofer EMI follows its mission of supporting the German Federal Ministry of Defence (BMVg) as strategic partner for research and technology in the field of high-speed dynamics. This includes examining issues regarding the fields of protection and effectiveness as well as defense-related safety and

systems. Furthermore, the results are analyzed with respect to their possible relevance to the Bundeswehr and its required technological capabilities in the future.

For us, the ability of capturing exact data regarding the behavior of materials, components and subsystems in dynamic experiments under laboratory conditions is of high relevance. We conduct these experiments with measurement technologies adjusted to the high requirements of time- and spatial resolution and to rough environment conditions. These enable us to transform the observed phenomena into suitable model descriptions and to analyze cases of application on the basis of numerical simulations and modeling. From the results, we derive technological solutions.

The following chapter outlines topics addressed in research projects with funding by the German Federal Ministry of Defence.

*Photo: Fraunhofer EMI acts as partner of the Bundeswehr (German Federal Armed Forces) providing analysis and consulting expertise concerning questions of research and technology.
© 2016 Bundeswehr Falk Bärwald.*



Dr. Matthias Wickert

Head of business unit Defense
Phone +49 761 2714-384
matthias.wickert@emi.fraunhofer.de

From security research to meteorite impact: research capabilities in the new high-power laser lab

High-performance lasers have developed into indispensable tools in the area of industrial material machining, which enable processes such as welding, cutting or drilling to be carried out quickly and precisely. Beyond these established procedures, new possible applications of high-power lasers are being investigated and developed at Fraunhofer EMI. The spectrum ranges from new applications in security research to military applications and examinations of the processes in geological materials during meteorite impact. The capacity of lasers to transport energy in a directed way over large distances plays a major role in these applications.

The potential of the application of lasers for the safe neutralization of explosive devices from a distance has already been demonstrated in numerous research projects, undertaken with various international partners. The benefit of using lasers is that the neutralization can be carried out at a distance, without people being in close proximity of the explosive charges. This process therefore contributes greatly to the safety of bomb squad team members. In addition, software tools for the assessment of safety during laser usage are also being developed at Fraunhofer EMI. The purpose of these tools is to identify possible danger zones and prepare measures for safe laser usage.

The development of new applications of high-power lasers has been furthered by the establishment of a new laser lab in the new building of Fraunhofer EMI in Freiburg.

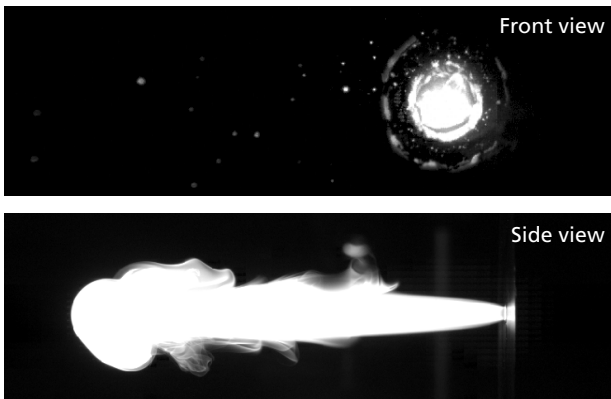

1 High-speed images of metal samples during laser irradiation with a power of five kilowatts and a beam diameter of 28 millimeters (top), and a power of ten kilowatts and a beam diameter of 2.6 millimeters (bottom).

In particular, the new laboratory allows for the detailed examination of the partly highly complex processes associated with the impact of laser as a function of beam parameters with specific high-speed measurement technology. The observations can then be used for the development of computer models for the predictive simulation of laser processes. Besides a high-power laser lab and a pulse-laser lab including a control room, there is also an application lab available for the preparation of samples and the development and testing of new measurement instruments.

As an example of the processes that occur during the beam-parameters-dependent laser impact, Figure 1 depicts two high-speed images of metal samples during laser exposure with different process parameters. The above picture shows the process for a laser output of five kilowatts with a beam diameter of 28 millimeters. In a high-speed video, it is possible to observe a quick abrasion of a thin layer of the surface, followed by melting of the material in the area of the laser beam. In contrast, the energy input in the below picture with a laser output of ten kilowatts and a beam diameter of 2.6 millimeters is locally by far higher concentrated and results in a fast increase in temperature beyond the boiling point of the metal. This rapid increase results in the formation of an expanding vapor or plasma cloud, which is further heated by the laser beam and thereby becomes partially ionized.

Generally, the energy transfer from the laser beam onto the sample is a question of fundamental importance for laser applications. The transferred energy is physically referred to as effective absorptivity. Exemplary laboratory examinations at Fraunhofer EMI have shown that the effective absorptivity can be in the order of 60 percent for laser intensities as shown in the static experiment in Figure 1. The test series in Figure 2, however, shows that under certain circumstances significantly lower values can be measured at very high intensities. The cause for this decrease in absorptivity is due to the interplay between the laser beam and the expanding vapor or plasma cloud, in which a part of the incoming laser energy is absorbed. This leads to a decrease in the power of the laser beam on the surface of the specimen and in the heating rate. In the newly equipped lab, the dynamics of these processes

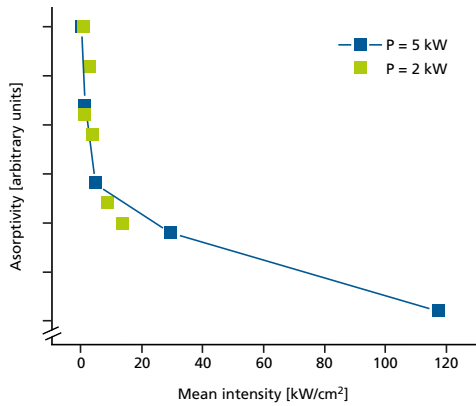

2 The formation of a vapor or plasma cloud influences the energy transfer from the laser beam onto the metal sample and at high laser intensities leads to a decrease in the effective absorptivity.

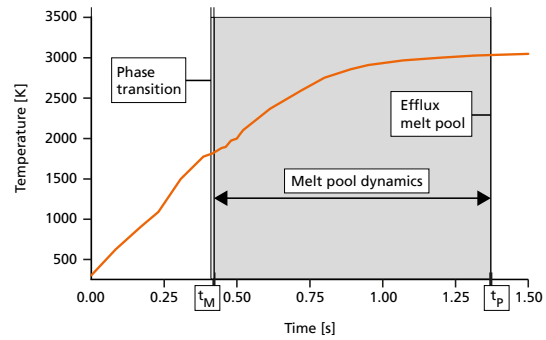

3 Simulation of the temporal temperature evolution on the backside of a metal plate during laser impact.

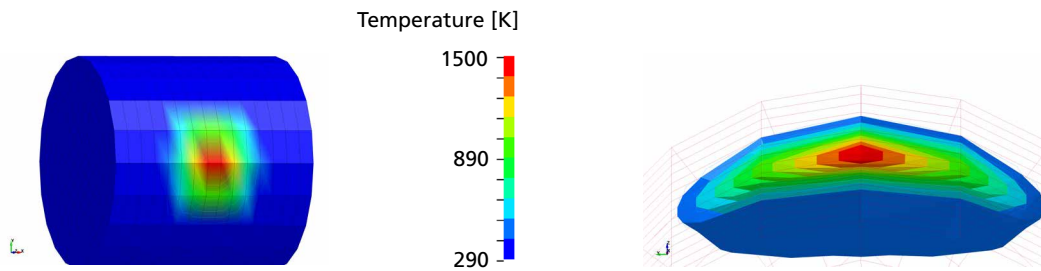

4 Simulation results of the impact of an intense laser beam on a cylinder sample from two perspectives. Left: temperature distribution on the upper surface, right: spatial temperature distribution inside the sample.

as well as the intensity-dependent material parameters can be scientifically examined using the latest measuring technology. The obtained results can then be applied in the optimization of laser processes.

Moreover, the material properties obtained in these investigations are also used in computer simulations which are developed at EMI for the calculation of thermal effects in objects exposed to laser impact. This allows, for example, to calculate the heating of a specimen during laser machining, dependent on laser parameters, while also considering energy coupling, heat transfer processes and phase transitions (melting and evaporation of materials, see Figure 1) for specific materials and various sample geometries. Figure 3 depicts a simple example of the temporal temperature evolution during laser impact on the backside of a metal plate. The influence of the phase transition on the temperature increase during melting of the sample is visible. By means of a cylindrical

sample body, Figure 4 illustrates that the temperature distribution can also be modeled for more complex geometries with curved surfaces.



Contact
Dr. Jens Osterholz
 jens.osterholz@emi.fraunhofer.de

Modeling the laser irradiation of energetic materials

The examination of the effect of intense laser radiation on energetic materials is a topic of considerable importance for security and defense research. The application of high-power lasers offers, among others, great potential in the development of new procedures for the safe disarming of explosive devices, and for the protection against threats like mortar shells and rockets for military camps. In the past, thereby occurring processes could not be adequately described but were recently experimentally and numerically compiled in a doctoral thesis.

The laser cook-off

In order to assess the safety risk of explosive materials during a fire, certain established cook-off tests are used in which energetic materials are slowly heated until the point of thermal ignition (Figure 1). Analogously, the heating of energetic materials with a high-power laser is also considered a laser cook-off. In contrast to a conventional cook-off, the laser causes a local heating with a higher heating rate. This in turn entails a larger temperature gradient in the energetic material.

A cook-off begins with the pre-ignition regime (Figure 1), in which the energetic material is heated and an exothermic reaction begins, that is, chemical energy is released. The reaction becomes self-sustaining the moment when more chemical energy is released than can be dissipated.

This marks the time to thermal ignition. The following post-ignition regime is characterized by the fast reaction of the available energetic material. The quick release and expansion of gaseous reaction products characterizes the explosive mechanical impact of energetic materials. While it is of interest if and when an ignition occurs in the pre-ignition regime, in the post-ignition regime, the question of the reaction strength is in the focus.

Experimental investigation of the laser cook-off

For the systematic analysis of processes occurring during laser impact on energetic materials, numerous experimental investigations have already been carried out at Fraunhofer EMI. For example, cylinder-shaped reference specimens, as depicted in Figure 2, were filled with explosive materials and then irradiated with a high-power laser in a special lab. The involved processes can be recorded and analyzed in detail with special high-speed measurement technology, with high-speed cameras and flash X-ray tubes. The pre-ignition regime generally lasts in the order of seconds, while the post-ignition regime is completed within microseconds.

Setup of a simulation environment

In order to gain a detailed understanding, a simulation environment was created in which the total reaction process including the heating-up phase and thermal ignition

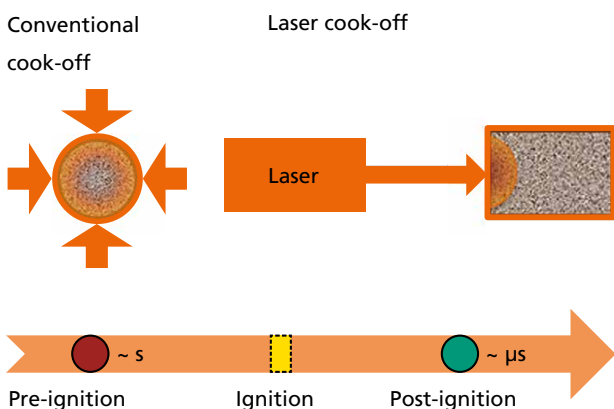

1 Illustration of a conventional cook-off and a laser cook-off. Both are characterized by a thermal ignition and the progression from a slow pre-ignition regime to ignition to the fast post-ignition regime.

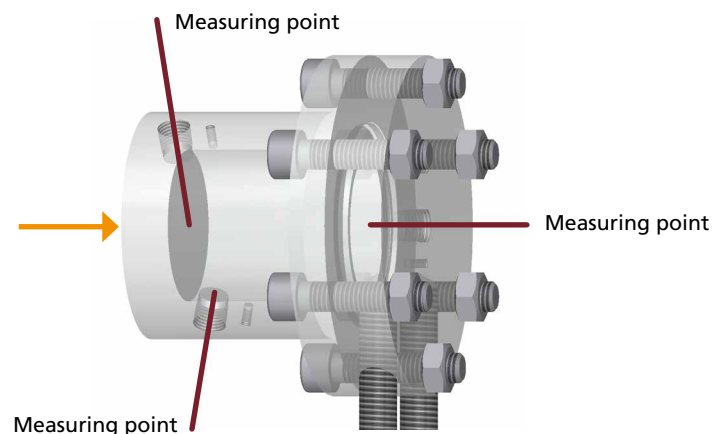

2 CAD picture of a developed sample with a wall thickness of one centimeter and screw threads for pressure-sealed bolting used for temperature measurement inside the sample during laser irradiation.

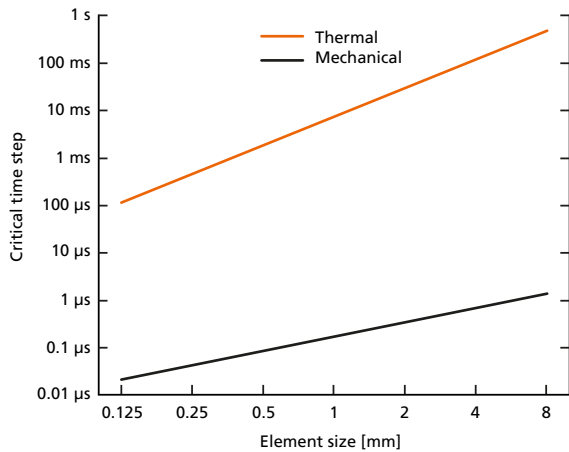

3 Comparison of the critical thermal and mechanical time steps for various element sizes.

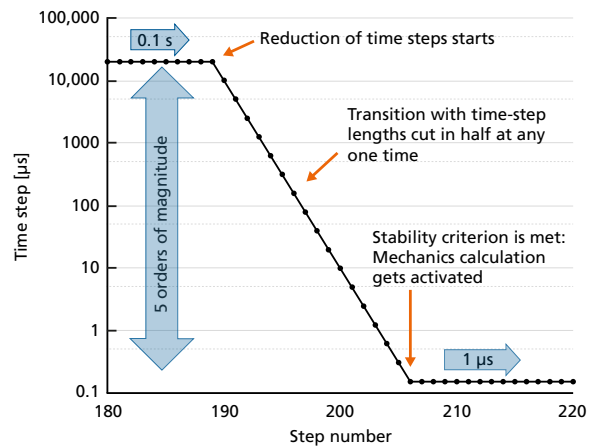

4 Exemplary time-step reduction of the multi-time-scale approach.

can be described. The modeling of relevant processes succeeded simply based upon physical principles and material parameters from scientific literature. The simulation environment was developed based upon an existing hydrocode, since hydrocodes are ideal for simulations of the highly dynamic post-ignition regime. The hydrocode was expanded to model not only the mechanical processes but also laser-induced energy coupling as well as thermal and chemical processes.

A particular challenge arose due to the vastly different time scales of the individual processes. The time to ignition when using a laser at the lowest power of one kilowatt was at approximately one minute. The simulation of such a long process in an explicitly integrated hydrocode would take too long due to the small, critical mechanical time step in the order of one microsecond. For that reason, a multi-time-scale approach was developed in which the mechanical processes could be neglected and instead, the larger critical time step of the heat conduction is used – in this case, approximately 100,000 times larger. Figure 3 shows the two stability criteria for steel as a function of the element size. If the mechanical processes in the post-ignition regime, and also shortly before ignition, are taken into consideration, the multi-time-scale approach will allow for a time step reduction (see Figure 4). As soon as the time step lies under the value of the mechanical stability criterion, not only the energy balance but also the mass balance and impulse balance can be solved.

Simulation of the pre-ignition regime

The first step was to model the pre-ignition regime, taking thermal and chemical processes into consideration while disregarding mechanical processes. The simulation includes the coupling of laser energy onto the steel casing, the heat conduction through the steel casing and into the energetic material, and its chemical reaction using a reaction law with Arrhenius kinetics. A procedure for temperature calculation was developed and validated for this case, which allows for the consideration of a temperature-dependent specific heat capacity for the hydrocode-typical explicit temporal integration procedure.

The cylindrical specimens that were irradiated in the experiment were modeled in three dimensions and with quarter-symmetry in the simulation. Figure 5 depicts the simulated distribution of the temperature and the reaction progress variable “Lambda”, λ , at the moment of ignition using a laser power of one kilowatt. The simulation environment was validated by the experimental measurement data. In Figure 6, the right graph depicts experimental and simulated temperature curves for a laser power of one kilowatt, while on the left, resulting times to ignition for a laser power of up to five kilowatts are illustrated. Within the expected range of absorptivity, the accordance of the experimental values with the simulation results is very good.

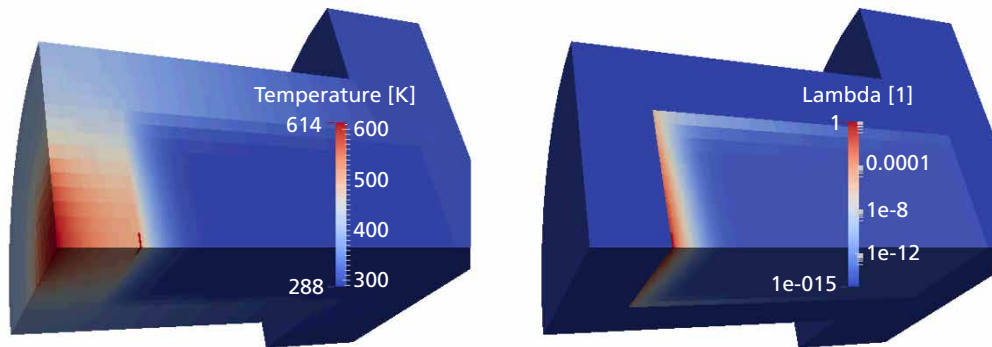

5 Simulated distribution of temperature and reaction progress for a laser power of one kilowatt and 50 percent absorption at the time of ignition after about one minute.

Thermal-chemical-mechanical simulation of the entire laser cook-off

An important alteration in the modeling approach is the possibility to simulate mechanical processes and, thereby, the post-ignition regime. A model for the energetic material was implemented in addition to the above described multi-time-scale approach. This model can describe the simultaneous occurrence of solid reactants and gaseous products during the chemical reaction with a rule of mixture in a numerical element. Accordingly, the specific volumes v and specific internal energies e of the two species (solid_s, gas_g) weighted by the progress of the reaction λ add up to the volume or energy of the entire element, $v = (1 - \lambda) v_s + \lambda v_g$ and $e = (1 - \lambda) e_s + \lambda e_g$. It is assumed that both species are in thermal and mechanical equilibrium, which means their pressure and temperature are the same $p = p_s(v_s, e_s) = p_g(v_g, e_g)$ and $T = T_s(v_s, e_s) = T_g(v_g, e_g)$. The phase pressures and temperatures were described with thermal and caloric equations of state, respectively. The material model is solved by iteration.

The calculation of the above described material models is computationally intensive. For the typical high temperature gradient present in a laser cook-off, fine resolution of the energetic material is required to be able to reliably predict the experimental times to ignition. This in turn results in impractically high computing times. In order to obtain a sufficiently exact result, even with a lower resolution, a temperature interpolation approach was developed for the reaction law. As opposed to a constant temperature, a piecewise linear temperature distribution in an element is assumed, inserted into the Arrhenius law, and then

integrated over the element volume. The convergence of this procedure could be proven by numerical analyses, even for less fine resolutions. Thereby, a complete, exact and computationally efficient laser cook-off simulation, from the pre-ignition regime to the ignition to the post-ignition regime, is possible.

To demonstrate the potential of this procedure, Figure 7 depicts the simulation of the processes in the post-ignition regime, in which the conversion of the explosive material following the ignition can be calculated using a known, pressure-dependent reaction model. The development of a detonation wave after the thermal ignition and an additional induction time can also be modeled for the laser cook-off. Based upon the power of the simulation environment, future works could, among other things, coordinate the modeling of a reaction in the post-ignition regime with experimental results even better, including non-detonating reactions.

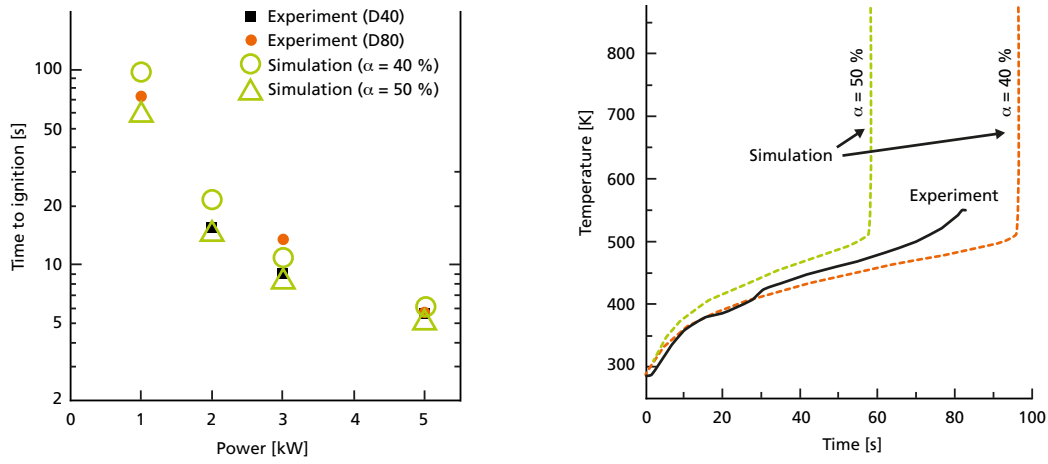

6 Successful validation of the simulation environment via a comparison of the measured and simulated times to ignition for different laser powers (left) and the temperature increase for a laser power of one kilowatt (right).

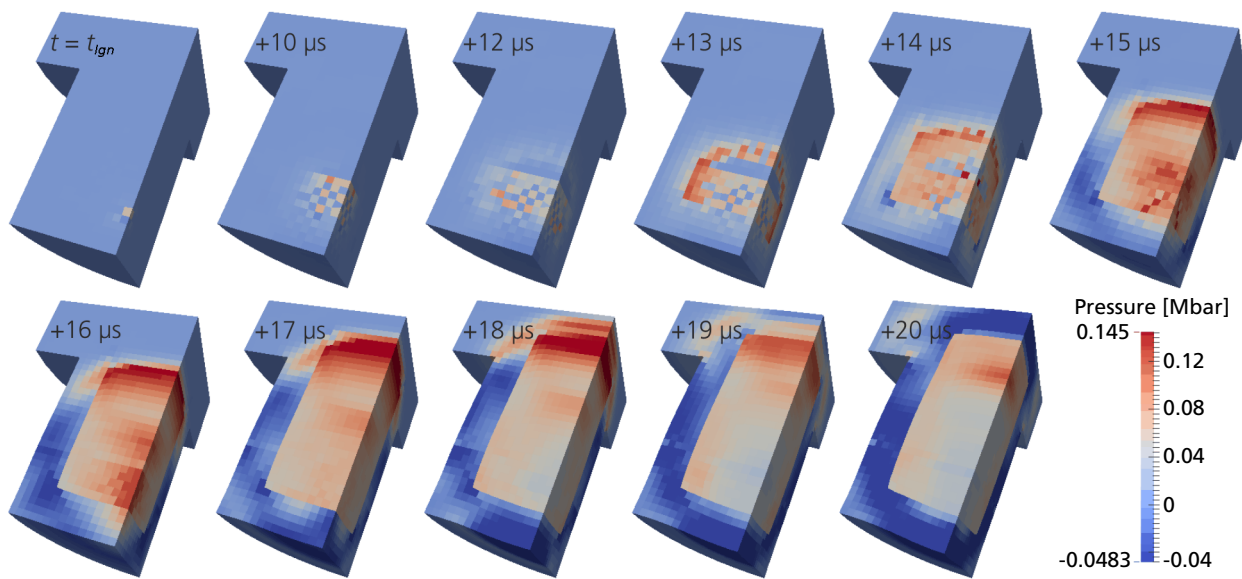

7 The simulated pressure distribution in the post-ignition regime. The time specifications are in reference to the time of ignition t_{ign} . A steady detonation wave is formed at around 15 microseconds after ignition, which reaches the end of the sample two microseconds later.



Contact

Dr. Martin Lück

martin.lueck@emi.fraunhofer.de

Development of new testing methods for the dynamic characterization of hybrid joints in our new laboratory for multi-material design

Special attention is currently being given to hybrid structures and joints at the new laboratory. This development evolved from the understanding that a purposeful multi-material design greatly contributes to the best possible use of various material properties and thus optimizes the behavior of structural components under dynamic loading. For hybrid joints, various joining methods (such as bonding and riveting) are combined in order to optimize the joint properties in case of damage in terms of material stiffness, strength, and energy absorption. The methodology development for the characterization of hybrid joints is carried out based on the fundamental understanding of the behavior of joint partners and of individual joining methods. An iterative “design of experiment” process entailing experiments and a numerical as well as analytical assessment of the results is pursued for this method development.

It is extremely important to be able to qualitatively characterize the properties of materials and joints during dynamic loading. This is essential for component design with numerical simulations for extreme loading scenarios such as crash, impact, and detonation. For this purpose, two split Hopkinson bars, one for compressive and one for tensile loads, are available in the lab. With the split Hopkinson bars, experiments for the characterization of a wide spectrum of materials from metals and plastics to composites and joint connections are carried out and refined. With the results from these newly developed testing methods, the basis for an increasingly virtual product design is formed.



Contact

Dr. Michael May

michael.may@emi.fraunhofer.de

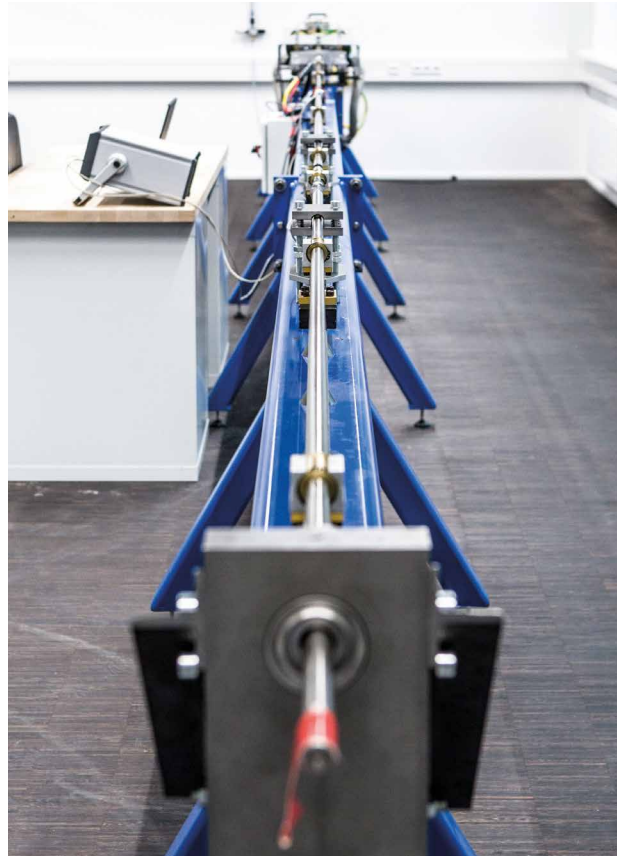

1 Split Hopkinson tension bar in the new laboratory for multi-material design.



2 Hybrid joint after tensile test at the split Hopkinson tension bar at ten meters per second.

EMI-developed tools as standard software used by the Bundeswehr for risk analyses of ammunition storage

Protection and safety provisions regulate the ammunition storage undertaken by the Bundeswehr (German Federal Armed Forces). EMI develops the software ASASP (Ammunition Storage And Site Planning Tool) in coordination with the Bundeswehr Technical Center for Protective and Special Technologies (WTD 52). This tool supports the safe planning of ammunition storage sites in conformity with the rules. Furthermore, this tool assists in the decision-making regarding risk management processes in specific cases where the protection standards of the given regulations cannot be realized. The ASASP program guides through the planning process of ammunition storage sites while simultaneously assessing the pertinent requirements. ASASP as a special program is available to the Bundeswehr IT service provider BWI and is explicitly mentioned as an aid in the guideline manual "munition-technical safety

for ammunition storage during operation" so that it can also be implemented in the operational planning within the scope of the German KFOR mandate (KFOR: Kosovo Force), and complementarily, in multi-national exercises. Currently, ASASP is being expanded for the planning of stationary storage facilities, so that capacity assessments and optimization within single storage sites or between different storage sites are possible. The central Bundeswehr guideline "risk management for ammunition storage" also contains the possibility of conducting a software supported risk analysis. Besides ASASP, other tools developed at EMI such as ESQRA-GE (Explosives Safety Quantitative Risk Analysis – Germany), BREAS (Blast Response Assessment of Structures) and the Klotz-Group-Engineering-Tool are noteworthy.

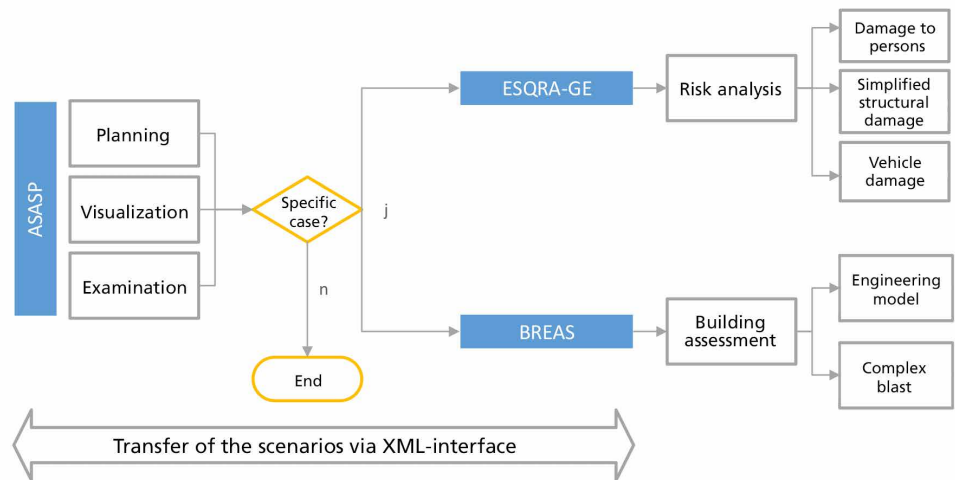

1 EMI software suite for the planning and risk analysis of ammunition storage sites of the Bundeswehr.



Contact

Dr. Malte von Ramin

malte.von.ramin@emi.fraunhofer.de

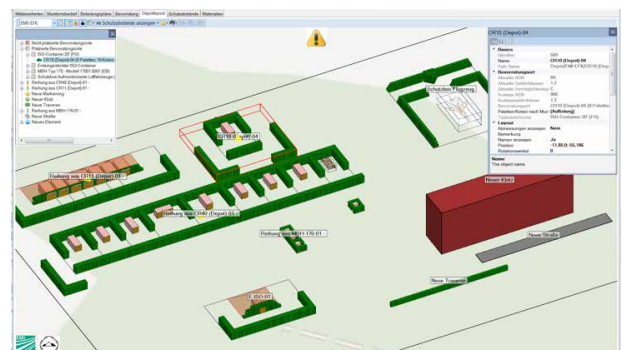

2 Layout plan for an ammunition field depot with ASASP.

Development of new interior ballistics codes

The main purpose of interior ballistics codes is the computer-aided design of guns and the respective ammunition. The codes in use in Germany are currently being modernized. During this transition, the program SimIB (simulation tool interior ballistics, German: Simulationstool Innenballistik) was developed at Fraunhofer EMI and has been used by the Federal Office of Bundeswehr Equipment, Information Technology and In-Service Support (BAAINBw), other institutes, and industry since 2015. SimIB replaces an old code and has various additional functions. For example, not only is a model for a classical powder gun available but also a model for dual-chamber systems, which can be used for the calculation of various ammunitions (see Figure 1). Furthermore, user-subroutines allow for the application of user-defined parameters.

As a so-called 0D model (energy model) is used for SimIB, effects due to ignition of propellant powder such as grain pressure or shock waves (see Figure 2) cannot be captured. Hence, the development a new gas-dynamical 1D software, SimIB-1D, has been under way since 2015. In this software, a reactive two-phase flow of gas and propellant powder is computed, with models for ignition, flow resistances of the powder bed, and the interaction between the propellant powder particles being implemented. Subsequently, an upgrade to a 2D/3D system is planned. A family of modern interior ballistics codes will be available in the near future that will be utilizable and upgradeable for the German Federal Armed Forces in the long run.



Contact

Axel Sättler

axel.saettler@emi.fraunhofer.de

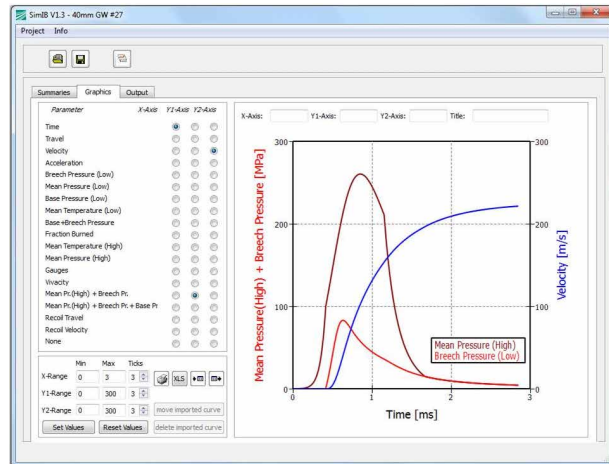

1 SimIB user interface with calculation results for a dual-chamber system. The chronological sequences of the projectile velocity (blue) as well as the gas pressures in the high-pressure combustion chamber (brown) and in the low-pressure combustion chamber (red) are depicted.

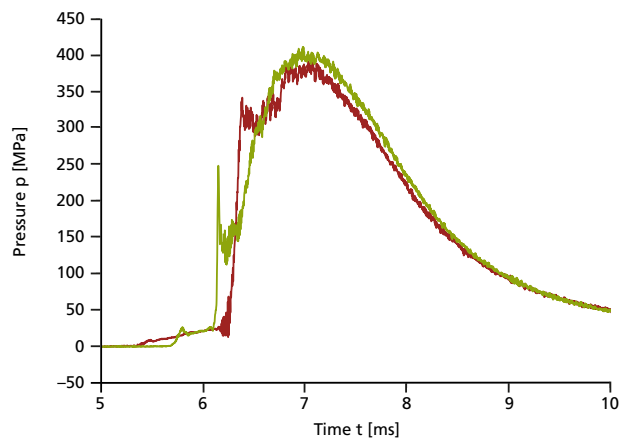

2 Strong shock waves in the charge chamber during ballistic testing with a laboratory accelerator at EMI. Pressure curve at two different measurement points in the charge chamber.

Automated X-ray-CT analysis of explosives – cavity search in the 3D microworld

The requirements explosive materials products have to meet are extremely high and sometimes in conflict with each other. They are supposed to reliably ignite at the correct time point, but they need to be able to be safely handled and transported before then. In order to meet these requirements, insensitive explosives are being developed. These can be highly loaded mechanically, without producing an explosive reaction. Current research is examining which factor may play a significant role in determining the sensitivity of an explosive material. Inner cavities, the size of a few dozen micrometers, form during the production of explosive grains, which are themselves only fractions of a millimeter in size. Fraunhofer EMI is examining this correlation via microcomputed tomography (μ CT) and through the analysis of the thereby created 3D data records. For this purpose, samples in the size of a few cubic millimeters (which still entail up to 1000 explosive grains) are scanned and reconstructed with a resolution of circa two to three micrometers. In order to minimize the noise and non-real interfering structures in the 3D datasets without losing fine structures such as corners or cavities, the artefact-corrector developed at EMI was implemented. Subsequently, single grains are identified and cavities within said grains are searched for. Although commercial software is available on the market for both tasks, a unique software had to be developed at EMI for the automated combination of both tasks. This software analyzes every found grain individually, whereby cavity space can be categorized into "space between grains", "cavities in inspected grain", and "cavities in other grains". The resulting statistics allows for the classification of discovered defects.

This analysis is a great step towards the fully automated characterization of large amounts of samples as is necessary, for example, in product control. It is equally important for the researchers that grains which greatly deviate from the norm can be displayed as 3D objects. This way, grains can be visually examined and scientifically interpreted, rendering important analytical results.

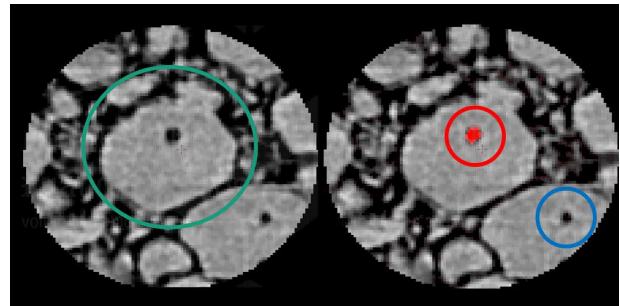

1 Left: Section of the measured volume; inspected grain is colored green. Right: A cavity (red) is found in the examined grain. Other cavities of the same volume (blue) were identified but not included in the statistic of the inspected grain.



Contact

Dr. Stefan Moser

stefan.moser@emi.fraunhofer.de

Functional lightweight design via multi-material construction in 3D printing: new potentials for active and adaptive armor and effect mechanisms and lightweight design

3D printing technology has evolved considerably over the last few years and is now applicable to a large range of materials. Even though the specific production methods differ greatly in terms of technology and level of maturity, it can be said that all of them allow for greater freedom in shape- and material-structuring due to the nature of their additive, layered composition. However, certain limitations exist in most of the techniques, particularly in the established metal manufacturing methods, such as the fact that only one material can be utilized at a time.

It is of particular interest for lightweight design to be able to integrate various materials and functions into components. At Fraunhofer EMI, a multi-material design concept has been developed which allows for the integration of various materials as well as of functional elements (such as sensors) into the development of 3D-printed metallic structures. With this newly developed method, it is possible to fully implement conventionally built components with complex surfaces into the insides of 3D structures.

These new possibilities in function integration and multi-material design for 3D printing of structural components have great potential in defense applications. The combination of materials allows the beneficial usage of various material-specific characteristics and, thereby, an increase in performance. Furthermore, measurement data about the condition of the inside or hard-to-reach sections of a component can be gathered via integrated sensors and mechanisms. This in turn allows the activation or control of active or adaptive armor and effect mechanisms.

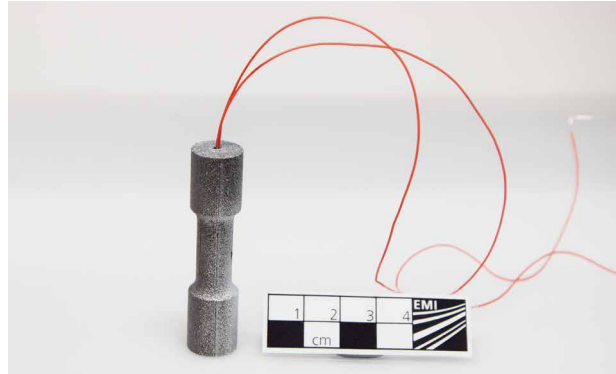

1 Sensors integrated into a 3D-printed metallic structure.



2 Multi-material structure: 3D-printed metallic structure with integrated, conventionally produced composite (split sectional view).



Contact

Klaus Hoschke

klaus.hoschke@emi.fraunhofer.de

Design of the engineering qualification model of the 12-unit nanosatellite ERNST

In the year 2017, the engineering model of the nanosatellite ERNST, a satellite with the measurements of 236 x 236 x 340 cubic millimeters, was constructed. ERNST is an acronym of German "experimentelle Raumfahrtanwendung basierend auf Nanosatellitentechnologie" (experimental space application based on nanosatellite technology). ERNST is supposed to measure the Earth's background

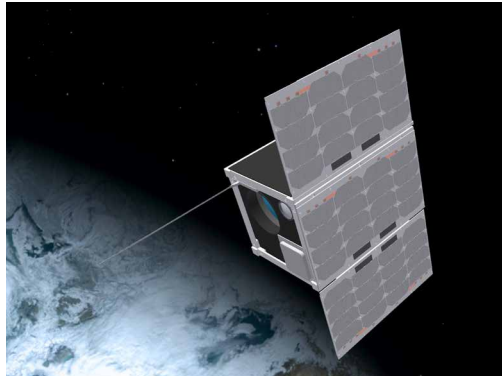

The nanosatellite ERNST carries an infrared camera for Earth observation.

in terms of mid-infrared wavelengths with a high-resolution camera. The first and foremost goal is to demonstrate the potential of this satellite class in signature detection as well as in complex remote sensing tasks. Now that the development and procurement of subsystems is complete, the integration and verification of the entire system is required.

EMI is a member of the Fraunhofer Group for Defense and Security VVS

The goal of the Fraunhofer Group for Defense and Security VVS is to research and develop technical solutions and systems for the protection of lives and safeguarding of infrastructures. The VVS research contributes to



For further information, visit www.vvs.fraunhofer.de

national precaution policies concerning defense and is instrumental to the future strategic orientation of the European security- and defense-research program.

Expert interview on European defense research with Dr. Stephanie Günther and Professor Klaus Thoma

Defense research has been a core mission of Fraunhofer EMI since the founding of the institute. This topic is increasingly becoming European, not least because Europe needs to collaborate in order to carry out research more economically. The Fraunhofer-Gesellschaft plays a key role in the collaborative European activities in the branch of defense research. We spoke with Professor Klaus Thoma and Dr. Stephanie Günther about this current issue.

A collaborative, intra-European defense policy was considered inconceivable for a long time. The EU member states feared for their sovereignty, and higher individual expenditures that would come with such a collaboration. In 2016, the European Commission released its Defence Action Plan, which aims to utilize the expenditures of the EU states for joint defense capacities more efficiently to increase the overall security in Europe, and to support competition and innovation in the industry. The European Defence Union that, for a long time, has been considered impossible will thereby become a reality. Professor Thoma, how was this collaboration finally made possible?

Thoma: Based upon the model of the established European security research, Europe is trying to build up a pan-European defense research network. The European Commission decided to financially support this collaboration in defense-oriented research in 2015. For this purpose, a Group of Personalities (GoP) was founded, which presented a plan for the development of European defense research. The president of the Fraunhofer-Gesellschaft Professor Reimund Neugebauer and I were named by the German Federal Ministry of Education and Research (BMBF) and the Federal Ministry of Defence (BMVg) to be the German GoP representatives for the European Commission. We worked closely with other delegates from national and international industry and research and presented the jointly written report "European Defence Research" in February 2015. At the same time, the Commission developed a global strategy for Europe. Both of these assessments were positively received by the European Council in the summer of 2016 and paved the way for the European Defence Action Plan. This official mandate given to the European Commission by the heads of states and



1 For a long time, joint European defense research was considered inconceivable – now it is becoming reality. We addressed this topic in an expert interview.

governments of the individual states describes a joint strategy for the future and development of defense policy in Europe.

European Commission President Jean-Claude Juncker said in his State of the Union Address 2016 that "Europe can no longer afford to piggy-back on the military might of others (...) Because it is only by working together that Europe will be able to defend itself at home and abroad". Which reasons lie behind the objective to unite Europe into a defense union?

Thoma: The most important reason behind this decision is efficiency. While Europe, taken together, spends only half as much on its defense as the USA, it turns out, it is not even half as efficient. This is due to fragmented defense markets and considerable doubling of expenditures of the single states. For example, the European Union has more than 178 different weapon systems at its disposal, the USA only more than about 30. Furthermore, the individual European states can no longer afford many of the expenditures. By so-called "pooling" and "sharing", it may be possible to remediate the deficiencies in partially dramatically under-financed armies. Another important reason is strategic autonomy. At the moment, certain components and technologies cannot be produced in Europe, yet are strategically vital. It is important to become as autonomous as possible when it comes to critical technologies. This can only be granted if intra-European collaboration succeeds.

Europe is facing great challenges including terrorism, crime, influx of refugees, political and economic deficits, climate change, resource scarcity, and population growth. Furthermore, changing transatlantic relationships along with new threats arising from technological changes such as cyberattacks or chemical, biological and radiological attacks also need to be kept in mind. Overall, Europe wants to be a security provider, namely an institution that is stable in its position and provides security, which is vital for its inhabitants to live safely in Europe.

Günther: The point is that Europe wants to be taken seriously as a global player. One cannot assume that the USA or Russia will handle all the problems of the world in a good way for Europe too. If Europe really wants to act on the same level as other powerful nations, it also has to take its share of responsibility.

Is there a superordinate entity that will coordinate this European defense?

Thoma: With the new approach, European grants will be supplied for joint research projects. As this entails large-scale calls for proposals and large sums of money, a large agency is required to steer, initiate, and control these procedures. In the civilian sector, the Research Executive Agency (REA) holds this position. For the military sector, this role is still open and under discussion. The European Defence Agency (EDA) was founded in 2004 to be the superordinate entity for European defense projects. EDA might take the role of this required superordinate entity.



2 Dr. Stephanie Günther has gathered a lot of practical experience in EU project application.

All decisions regarding a European Defence Union are approved by the European Council, and thus also by German government representatives. Why then is so little known about these new developments in Germany?

Thoma: I wonder about that myself every time I go to Brussels. In other nations, it is completely different: Defense plays a larger role. France and Great Britain succeed more or less in spending two percent of their gross domestic product on defense. The topic of defense is appreciated very differently in other European nations. The impulse to justify any defense-related spending is a German phenomenon.

One of the main goals of the European Defence Action Plan is to establish a European Defence Fund. According to the European Commission, this fund is to promote investment in joint research and joint development of defense equipment and technology. How will these research projects be financed?

Thoma: As described in the Action Plan, the European Commission has determined that the fund will have two complementary but legally different financing structures ("windows"): a "research window" and a "capability window". Based on the model of security research, an initial Preparatory Action on Defence Research will be coordinated by the EDA. This test run of an exemplary defense research program is set for three years (2017 to 2019) and entails a financial support of circa 90 million euros. After 2020, the development and research program will continue with even more financial backing. It is estimated that approximately 500 million euros per year will be made available for continued research.

What is this Preparatory Action exactly?

Günther: As part of the Preparatory Action, "calls" on various themes are published, for which one can apply with a suitable project idea and a good consortium. Last year, for example, there were three calls that targeted research and development in varying stages of maturity. We participated in a consortium that applied for funding with a project on protective vests. We received a very good assessment with 12.5 points out of possible 15 points, but are still placed on the waiting list. This year again, further topics will be published.

Defense research is technically a nationally organized field of activity. How does this work with the additional parallel European level?

Günther: Having two levels of organization is not contradictory and is also common in other research fields. In aviation research, an established coordination process between national levels and Europe ensures that topics are not repeated but instead complement each other.

Thoma: A good example for this are the intentions of Germany and France. July 13, 2017, both countries, under the direction of President Macron and Chancellor Merkel in Paris, decided to carry out nine large joint projects. This included, for example, the development of a new battle tank and a new Eurofighter. One country alone could never undertake such a project.

Dr. Günther, you are the contact person for all matters concerning the EU application in the research field defense at EMI. What does this task specifically entail?

Günther: The EU, or the EDA, publishes calls for proposals. I screen these calls to determine which ones fit the research topics of EMI and then contact the appropriate researchers. Sometimes, an idea that addresses the call is immediately formed; at other times, the colleagues meet up with each other to brainstorm possible ideas.

Then, an information day takes place in Brussels, where all the current calls are presented. I attend as a representative for EMI. Usually, a partnering event is also included, which offers the possibility to present own project ideas and potentially find project partners. Successful consortia are often formed during these events, then project ideas are further developed, sharpened and then compiled into a hopefully successful proposal.

It is often clear from the beginning which partners would be suitable for a collaboration, and they are directly contacted to inquire if they would be interested in a joint EU project. I support the researchers in their partner search and also help to sharpen the ideas and formulate a good proposal. The lead time for EU projects in defense research is significantly shorter than in, for example, security research, where it is about one year. In defense research, we

have a lead time of only a few months. In order to complete a proposal in such a timely manner, it is helpful to have experience in the EU application process. The process of such EU projects is always quite similar and the Preparatory Action for the new EU defense research program conforms to the formal framework conditions of previously established research programs. I gladly offer my experience with previous EU projects to my colleagues, and advise and support them during the creation and submission of their proposals.

What is your vision for Europe in 10 or 20 years? Will we have a joint army and will Europe develop itself into a collaborative research environment?

Thoma: I am convinced that Europe will have to come together and in many ways act as a joined Union in order to prevent being just a collection of mini nations in 10 or 20 years that are dominated by great powers such as China, USA, and Russia. For this purpose, a joint army is not a necessity, but Europe needs to step up as a dominant economic power, which protects its democracy and territory and is thus a global player to be taken seriously. Challenges such as climate change, political insecurity or population growth and migration can only be addressed by a united Europe.

Günther: To some extent, the collaborative research environment does already exist, and I think that the cooperation and exchange of ideas will increase even more in the future. Research profits immensely from such intra-European exchange. We gain new perspectives, learn about other approaches and can achieve much more together. Institutions such as EARTO (European Association of Research and Technology Organisations) already mirror this idea. As research is concerned, Europe is already going the right way.

Professor Klaus Thoma

A few weeks after this interview was conducted, Professor Klaus Thoma unexpectedly passed away. With his passing, the colleagues of Fraunhofer EMI and the Fraunhofer-Gesellschaft have lost a man who stood for fairness, honesty, reliability, and absolute commitment – a former institute director who broadened our research profile to include pioneering topics. As his colleagues and co-workers, we are deeply grateful for the many valuable years during which we could work with Klaus Thoma. We will miss him for his vision, advice, strategical instinct and his inexhaustible strength to bravely and resolutely approach and initiate new projects.

From 2015 to his passing, Klaus Thoma, as sherpa for the Fraunhofer President Reimund Neugebauer, was a member of the Group of Personalities (GoP) convened by the EU Commission. This group accompanies and supports European security research.

From 2008 to 2014, he was a member of the Research and Technology Advisory Council of the Federal Ministry of Defence (BMVg) and simultaneously, Head of the Scientific Advisory Board on Security Research of the German Federal Ministry of Education and Research (BMBF). He was a founding member and long-term chairman of the Fraunhofer Group for Defense and Security VVS. Additionally, he represented the Federal Republic of Germany in the NATO program Science for Peace and Security (SPS) from 2006 to 2008.

Professor Thoma was Director of Fraunhofer EMI from 1996 to 2014.



Dr. Stephanie Günther

Stephanie Günther is the main contact person for EMI researchers for inquiries regarding proposals for the European defense research program. She identifies suitable calls for EMI, supports the proposals from the first steps to finding partners to budget calculations to the final submission and the beginning of the project. She represents EMI at various networks and platforms in Brussels and draws on her profound experience with EU projects, many of them belonging to the civilian security research sector.



Contact

stephanie.guenther@emi.fraunhofer.de

BUSINESS UNIT
SECURITY



BUSINESS UNIT SECURITY



Constant development of new technologies, permanent change and increasing interconnection of complex systems are characteristics of today's world. Disruption of interrelated systems may pose a threat to the safety and security of society and the environment and may affect our sense of security. Security and stability are existential human needs, and the sense of individual and collective security is a requirement for prospering societies.

To meet these demands, the potential impact of these complex changes has to be evaluated, and suitable methods have to be developed and advanced. The security of people themselves, of goods, and the safety of technical systems have to be considered in a highly integrative analysis in order to ensure the development of resilient systems.

The focus is on the improved preparation for an unexpected, disruptive event by taking appropriate measures in order to allow for a fast recovery after such an event. In the field of engineering, resilience engineering provides the necessary practical measures and technologies to answer the call for resilience, safety and security.

The research presented in the following articles addresses classical safety analyses, analyses for the assessment and advancement of resilience and risk and vulnerability analyses. We describe methods for the improved prediction of probable damages of single objects and their propagation through corresponding networks. The main focus of the research activities lies on urban infrastructure and road infrastructure – both are key elements of modern societies. Additionally, we demonstrate how sensors contribute to security and resilience.

For the constant improvement of security and resilience, it is eminently important for people to be well-prepared for crises. This can also be achieved by specific continuing education contributing to more safety and security.

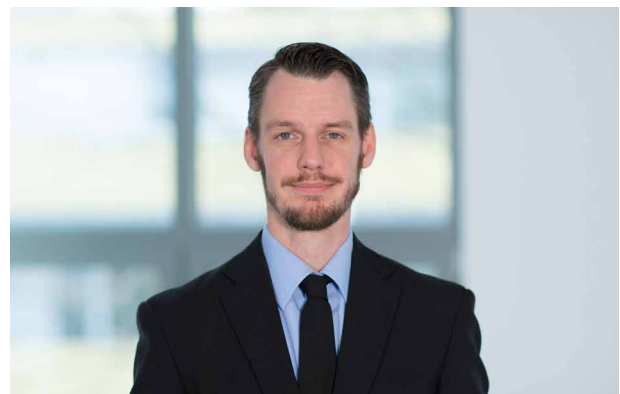

Photo: In the shock-tube facility BlastStar, glass panels are tested for safety in case of explosion.

Dr. Alexander Stolz

Head of business unit Security
Phone +49 7628 9050-646
alexander.stolz@emi.fraunhofer.de

Software solution for the analysis of the effects of explosive weapons in populated regions

The Geneva International Centre for Humanitarian Demining (GICHD) is a non-governmental expert organization which cooperates with governments, the United Nations and other organizations to minimize the humanitarian consequences of mines, cluster ammunition and other explosive hazards. Prompted by the strategical goal of improving

human safety, GICHD has launched the research project “Characterisation of Explosive Weapons” (CEW) to inspect the collateral damage caused by the use of explosive weapons in populated areas.

Due to the effective range of individual explosions as well as their imprecise and multiple usage, the effect of many explosive weapons extends beyond the intended impact area or misses it entirely. The outcome of this wide-range impact in populated regions is predominantly civilian damage. With its assessments in the CEW research project, GICHD wants to contribute to the international discussion on the responsible application of explosive weapons and aims to increase the safety of civilians. Important to note is that GICHD will not evaluate the application of such weapons in populated regions on a moral or legal basis but will provide a purely technical description of the consequences of such an application instead.

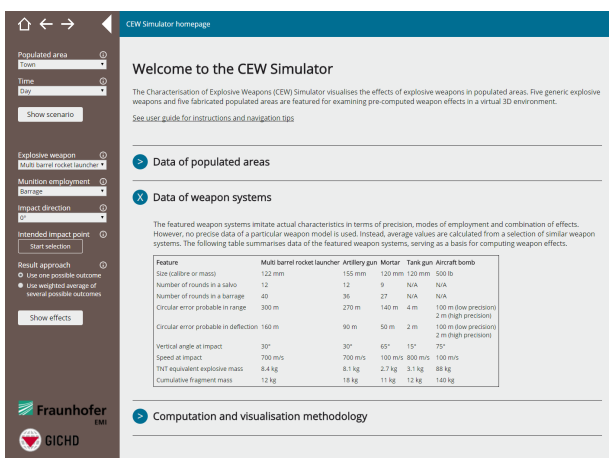

1 Current version of the graphical user interface for the CEW simulator with a sidebar for choosing possible scenarios, header and main field, which in this instance depicts the homepage with introductory text and, after choice of scenario, depicts the 3D visualization of said scenario.

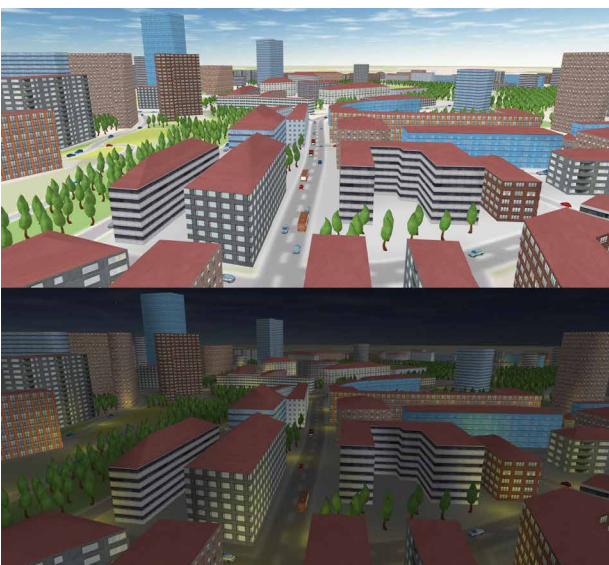

2 Screenshot of the 3D visualization of a fictitious large city in the CEW simulator during daytime (top) and nighttime (bottom).

As part of the CEW research project, GICHD has commissioned Fraunhofer EMI to develop a web-based software solution for examining the simulated effects of explosive weapons in populated regions. A significant requirement of the so-called CEW simulator is the possibility of a quick analysis. Time-consuming model creations and calculations, as they are common in computer simulations, shall be avoided. Instead, the CEW simulator is to provide pre-calculated scenarios, which can then be displayed and examined in a web browser.

Based upon these requirements, Fraunhofer EMI has developed a web application primarily consisting of a database for storing digital 3D models of populated regions and calculation results. Additionally, a graphical user interface (GUI) for the 3D visualization of these data was also created. Figure 1 depicts the current version of the user interface. The sidebar on the left provides different control elements and functions for selecting different scenarios. For example, the users of the CEW simulator can choose from five fictitious populated regions and two times of day, and from those, have a realistic, interactive 3D visualization displayed (Figure 2). The digital 3D models of the populated regions are permanently saved in the database of the web application and cannot be modi-

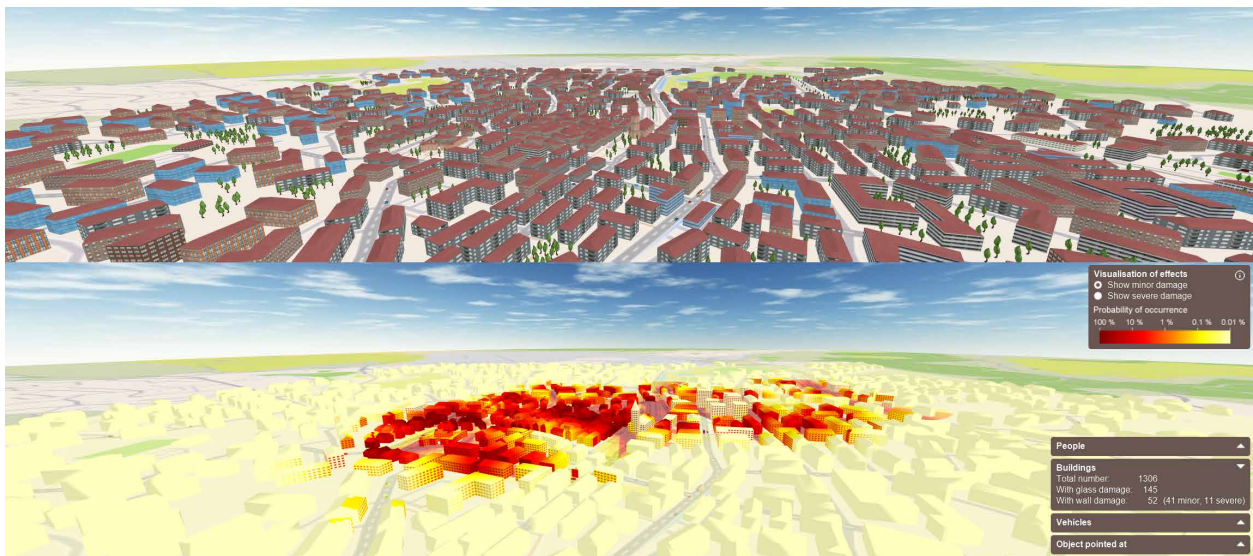

3 3D visualization of a fictitious small town in the CEW simulator, without (top) and with (bottom) illustration of effects of using multiple explosive weapons.

fied by the users. They were created in coordination with GICHD and entail, among others, various types of buildings and vehicles as well as the varying distribution of people outdoors, in buildings and in vehicles.

For exemplary scenarios, the CEW simulator provides pre-calculated explosion effects. The calculated scenarios were created according to the requirements of GICHD and imitate the precision and effectiveness of real explosive weapons by means of generic values. The computing environment created by Fraunhofer EMI to quantify the explosion effects uses a probabilistic approach in combination with established and freely available methods as well as conservative assumptions. Loads caused by the shock waves and fragments are ascertained by a simulated 3D propagation which takes shielding and focusing effects of buildings into account. Based upon that, the computing environment determines the expected individual and collective effects on buildings, vehicles and people. The calculation results of these exemplary scenarios stored in the database can be inspected by the users of the CEW simulator via the GUI. The application illustrates local, individual effects as differently colored surfaces in the 3D environment and renders collective effects as text. Figure 3 shows an exemplary result for the damage effects in a fictitious small town.

The CEW simulator developed for GICHD can thus be implemented for rapid visualizations of expected, general collateral damages caused by explosive weapons in populated regions. The users of the web application neither need to build scenarios nor carry out complex, time-consuming calculations. Instead, the pre-calculated results of approximately 130,000 scenario variations are readily available, which can be assessed in an interactive, virtual 3D environment. The intuitive and easy-to-use application is equipped with a modern GUI with 3D visualization and runs with all common web browsers.



Contact

Johannes Schäfer

johannes.schaefer@emi.fraunhofer.de

Advancement of a tool for the assessment of the resilience of critical infrastructure and integration into a web platform

Fraunhofer EMI, in collaboration with project partners of the European research project RESILENS (Realizing European Resilience for Critical Infrastructure), has developed a web-based tool for the assessment of the resilience of critical infrastructures. The user answers questions on a broad spectrum of different resilience aspects, including, for example, drawing up a business continuity plan or the establishment of (physical) protective measures. In the subsequent assessment, statements about the analyzed critical infrastructure can be deduced on different aggregation levels (Figure 1). Areas of potential improvements are then identified in the following step, and measures to be taken can be prioritized. The foundation for the development of this tool are data collected throughout many pilot projects by European businesses operating critical infrastructure, such as water and electricity supply as well as transport. Aspects of user guidance and of the general process development for the assessment and improvement of resilience in terms of a resilience management approach were taken into account during the data collection. Furthermore, Fraunhofer EMI was responsible for the development of an interactive online version of the resilience management guidelines. The establishment of suitable links between tool and guideline as well as the integration of both components into one consistent web platform (Figure 2) proved to be a significant advancement.



1 Visualization of the assessment results in regards to various components of resilience.

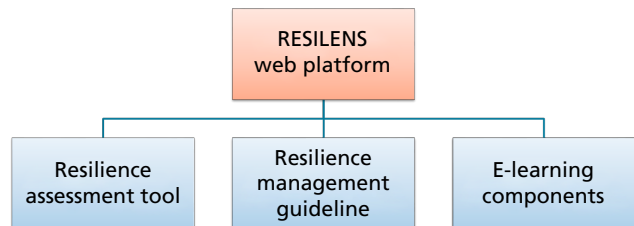

2 Structure of the RESILENS web platform: Fraunhofer EMI implements the tool for the assessment of the resilience of critical infrastructure as well as the online version of the resilience management guidelines.



Contact

Jörg Finger

joerg.finger@emi.fraunhofer.de

The new Sensor Lab at EMI

In the course of constructing the new EMI building, the Sensor Lab was established, in which measuring and sensor setups for various applications are developed and tested. The focus lies on energy-self-sufficient sensor networks that protect critical infrastructure. One example is the project SenSE4Metro for safety applications in railway systems, funded by the German Federal Ministry for Education and Research (BMBF). Fraunhofer EMI is developing an energy-self-sufficient scalable wireless sensor network with sensors for explosions, water ingress, smoke and fire in order to monitor large sections of tunnels. For the design and testing of the sensor networks, impact and vibration testing devices are available in the laboratory, which are also used for spacecraft verifications of payloads developed at Fraunhofer EMI.

Project example: more safety in tunnels during emergency responses

The German-Indian research project SenSE4Metro focuses on concepts dealing with the support of subway operators and rescue forces in case of a catastrophic event. For this project, Fraunhofer EMI is developing a security and emergency management system – based upon energy-self-sufficient, wireless sensor networks (WSN) – that detects fires, explosions or floods in tunnel systems. By using ultra-low-power electronic components, measurement principles and new protocols and algorithms for collecting and transferring data, an average consumption of 58 microwatts could be realized for some of the modular-based nodes. This extremely low energy consumption allows the use of a vibration energy harvester, which is



Contact

Dr. Martin Schimmerohn

martin.schimmerohn@emi.fraunhofer.de

currently in production and is based upon newly created analytical and numerical models. The first Indian-German workshop of the Initiative for Civil Security Research (IGI CSR) took place from February to March 2017. Members of diverse ministries as well as the scientific attaché for Germany, Stephan Lanzinger, met in Delhi, India. The first project results were positively assessed by the participating parties, including the funding bodies.

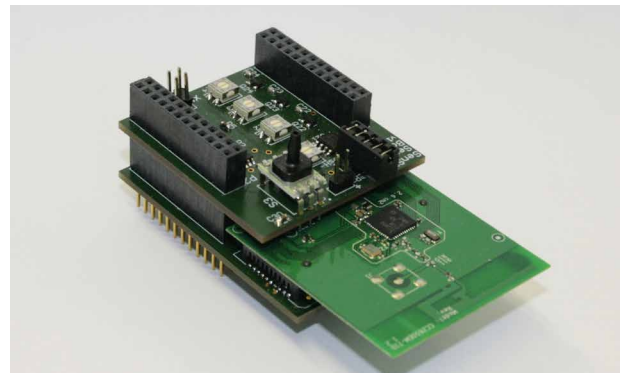

1 Wireless sensor node for the application in subway tunnels.



2 Participants of the first Indian-German workshop of the Initiative for Civil Security Research at the Indian Institute of Technology Delhi in India.



For further information, visit www.sense4metro.org

BUSINESS UNIT
AUTOMOTIVE



BUSINESS UNIT AUTOMOTIVE



The automotive industry is experiencing a rapidly progressing change worldwide: The introduction of disruptive technological innovations in the entire mobility sector is expected to lead to profound changes in the entire value chain of the industry.

In this context, the topic of crashworthiness remains a central and innovative field of research. "Vision Zero", the aim to have zero car-crash victims, is not least being driven by novel driver-assistance systems. By now, the concept of integral vehicle safety has asserted itself and combines passive and active safety measures. This concept constitutes an essential focus of research at Fraunhofer EMI. Driven by these complex requirements, the equipment for measurement at the Crash Center of the Fraunhofer-Gesellschaft could be advanced significantly within a cross-departmental collaboration. The Crash Center was adjusted to the demands of modern, highly instrumented crash experiments.

Photo: Crash using X-ray car-crash (X-CC) technology.

Again, one focus of research was to further develop our dynamic X-ray procedure with which the deformation behavior of previously hidden structures can be observed during a crash. So far, there is no other system of this kind worldwide. In addition to mainstream measurement methods, this system provides extra possibilities of observation for crash research and helps to clarify unanswered questions regarding the dynamic behavior of safety-relevant vehicle components.

Furthermore, scientists at EMI conduct research on the safety of electrical energy storages in the context of the increasing electrification of vehicles. Here, the topic of light-weight design on the basis of multi-material construction, in other words, hybrid materials, constitutes a centerpiece within the business unit.

In order to be able to describe or, ideally, even predict future injury risks within changing traffic situations, the research field of human modeling has been identified as a strategically important topic for the business unit.



Dr. Jens Fritsch

Head of business unit Automotive
Phone +49 761 2714-472
jens.fritsch@emi.fraunhofer.de

X-ray diagnostics in crash tests picks up speed

Fraunhofer EMI has been researching the potential of X-ray diagnostics in crash tests using the new X-ray car-crash (X-CC) technology at the Crash Center of the Fraunhofer-Gesellschaft since 2016. X-raying is an established material research technology, which in the industrial sector has thus far been restricted primarily to static and quasistatic analyses. With the X-CC technology, Fraunhofer EMI combines X-ray technology with highly dynamic deformation processes under crash conditions and thereby contributes to the overall understanding of the behavior of inner car structures during a crash. The results are included into the simulation for the optimization of structures, structural components or materials. The long-term goal is to obtain an X-ray video of the crash tests. This business branch of Fraunhofer EMI, which has developed into a large, successful research field, has sparked growing interest in industry and research. EMI develops new methods, simulations and fields of application, conducts industrial projects for notable clients and plans the continuous development of test setups for future studies.

Successful completion of various industry projects

As part of the Tech Center i-protect, Fraunhofer EMI inspected the application of X-ray technology in crash tests in collaboration with Daimler AG with the goal to make safety-related inner structural components of a vehicle visible, even during a crash test, and to combine them with computer-based simulation models in order to improve the predictive reliability of crash simulations. The project began in January 2016 and was successfully completed in 2018.

The focus of another industry project was on the experimental analysis of structural components using X-ray technology. With the additional use of a 3D high-speed scanner, the X-ray images could be spatially oriented, and a time-resolved model of the test data could be generated. The scanner was developed by Fraunhofer EMI in collaboration with Fraunhofer IOF and Fraunhofer SCAI and successfully implemented as part of the industry project. The application of this tool is an important step towards the combination of different technologies in the simulation. A third industry project dealt with the improvement of X-ray simulations for experimental designs as well as the assessment strategy, including the necessary

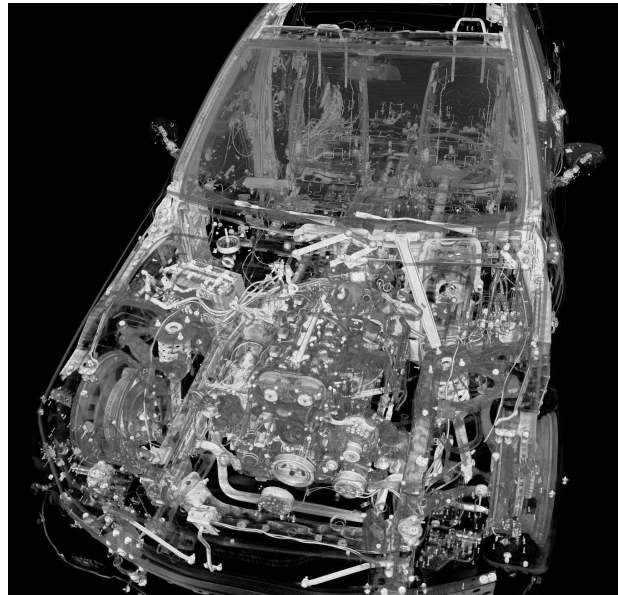

1 The behavior of safety-related inner vehicle structures can be examined with the ultra-high-speed X-ray technology.

© Daimler

algorithms. This project was also successfully completed this year.

Impressive research results

The research results of the X-CC technology are of great public interest. For example, the Fraunhofer EMI booth at the industrial trade fair Hannover Messe in April 2017, where researchers explained the X-ray technology using a replicated test setup, drew large numbers of visitors. The test vehicle, a Mercedes-Benz E-Class supplied by Daimler, and the simulated X-ray flash attracted many visitors from research, politics and the general public. Among the prominent visitors were the president of the Fraunhofer-Gesellschaft Professor Reimund Neugebauer along with the executive board members Professor Georg Rosenfeld and Professor Alexander Kurz, as well as Reinhard Bütikofer of the Green Party and EU Commissioner Günther Oettinger. X-ray technology is a sought-after subject for the expert audience as well, which is exemplified by the presentation on "X-ray examinations for high-speed dynamic applications" held by EMI experts Dr. Malte Kurfiss and Dr. Stefan Moser at the 17th Seminar D+S "Current questions in X-ray examination and radiation protection" in March 2017, hosted by the German Society

for Non-Destructive Testing. Dr. Malte Kurfiss also held a speech about high-speed X-rays in vehicle crash diagnostics at the Lightweight Design Conference hosted by the Fraunhofer Lightweight Design Alliance in November 2017.

Expansion of experimental opportunities

An important step towards the goal of an X-ray video is the acquisition of a powerful X-ray source. Intense discussions with the world's leading manufacturers of linear accelerators led to a call for proposals with technical requirements clearly superior to current commercially available accelerators. The award procedure was successfully closed in December 2017. Parallel to the acquisition of the new X-ray source, its integration into the crash hall was also initiated. Radiation protection is an especially important challenge. A radiation protection concept was developed together with skilled experts from the Federal Office for Radiation Protection (BfS) and the company diondo GmbH. This concept was positively assessed by the responsible authorities and will be implemented in the next project phase. With the acquisition of the new linear accelerator LINAC, new experimental possibilities are now available to Fraunhofer EMI. Henceforth, vehicles can be screened completely with the very high energy of nine megaelectron volts. The frame rate of 1000 hertz envisioned for the final expansion stage allows faster X-ray diagnostics in vehicle crashes. The new equipment of the crash hall will be applied in the Fraunhofer-internal strategic market-driven pre-competitive research (MAVO), starting in April 2018. EMI, as part of the three-year-long project that is being funded with 3.2 million euros, will conduct research for the development of a fast X-ray detector and methods for

X-ray image analysis in cooperation with the Fraunhofer Development Center X-ray Technology EZRT. Other international industry projects will also profit from the new opportunities of the X-ray crash-test technology at EMI.

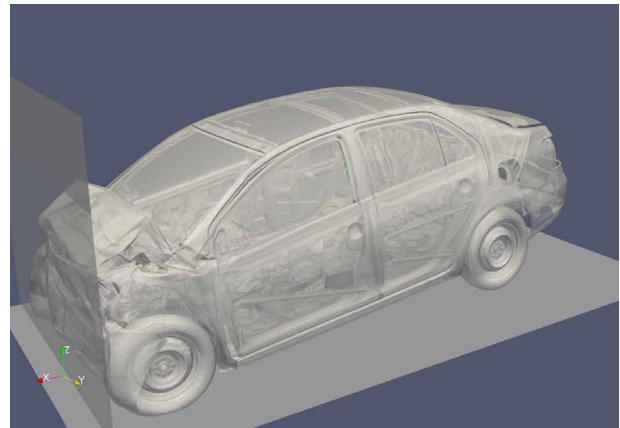

2 Finite-element crash simulation in a semi-transparent depiction.



3 The X-CC technology notably attracted the audience's interest at the trade fair Hannover Messe in 2017.



Contact

Dr. Malte Kurfiss

malte.kurfiss@emi.fraunhofer.de

Upgrade of measurement technology at the Crash Center

Industry partners continually set out increasingly complex requirements regarding the Crash Center of the Fraunhofer Gesellschaft. The Measurement and Sensor Technology Department at EMI has advanced and adapted the measurement equipment in the Crash Center to fit the requirements of modern, highly instrumented crash tests via cross-departmental cooperation. Measuring strain rate and acceleration is now possible directly on a test object with high channel count, thanks to a miniature, crash-proof data acquisition system and corresponding sensors. In combination with the available instrumented crash barrier, strain-, acceleration- and force-curves can be depicted synchronically as high-speed video clips in up to ten different views, with over 350 channels. This versatile instrumentation offers customers even more information to better understand the dynamic deformation processes in a crash.

Furthermore, the time needed between completing the crash test and providing the client with the test data was clearly shortened by the introduction of processes for the automated preparation, combination and synchronization of measured data from varying sources. This new measurement technique has already been successfully implemented in a major project due to the smart collaboration and supplementation of competences. Further follow-up projects have been acquired.

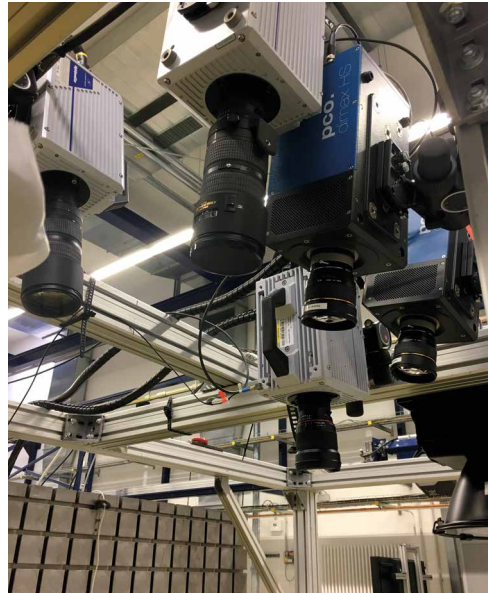

1 Setup with numerous high-speed video cameras for the observation of a crash situation. A stereo recording from above results in a "3D digital image correlation", and three images for a detailed view are obtained.

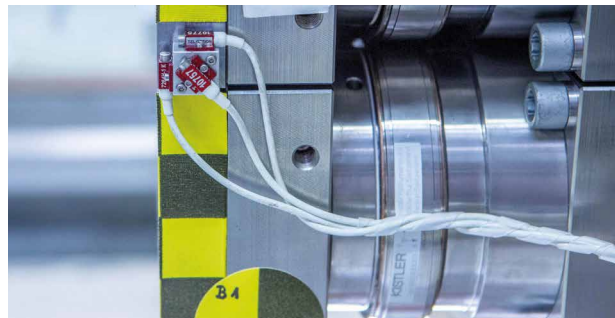

2 The forces and accelerations during a crash are recorded at numerous measuring points by triaxial sensors.



Contact

Dr. Sebastian Schopferer

sebastian.schopferer@emi.fraunhofer.de

Strain-rate effects caused by failure of battery cells

With increasing energy density of electrical energy-storage devices, their risk potential increases as well. Therefore, EMI is conducting experiments on failure mechanisms of lithium ion batteries under dynamic loading. Strain-rate effects that are relevant in the case of a crash are of particular interest. In order to meet the challenges posed by low cell thickness, experimental setups that prevent a transfer of high forces onto the test object were developed dependent on the used impactor and the stress level. Without an appropriate setup, a hard collision of the impactor on the supporting layers below the cell after the intrusion might not be avoided at high test velocities (see, for example, Figure 1). With the novel setup, however, it is possible to limit the impact force, as a steel piece (indicated in blue in Figure 1) punches out a piece of the underlying plate when its maximum shear force has been reached. This allows for the detailed examination of failure mechanisms at lower force levels.

Figure 2 shows the results of a test series of two types of pouch cells. The forces necessary for cell failure during intrusion are plotted as a function of intrusion velocity. An unexpected result was discovered during the examination of the cell types: The critical force values decrease with increasing loading velocity. However, this result cannot be generalized for all cell types, as for some, the opposite behavior was observed.

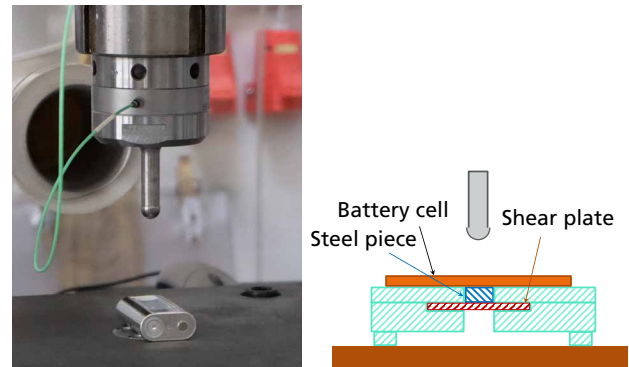

1 Experimental setup. Left: photograph. Right: sketch.

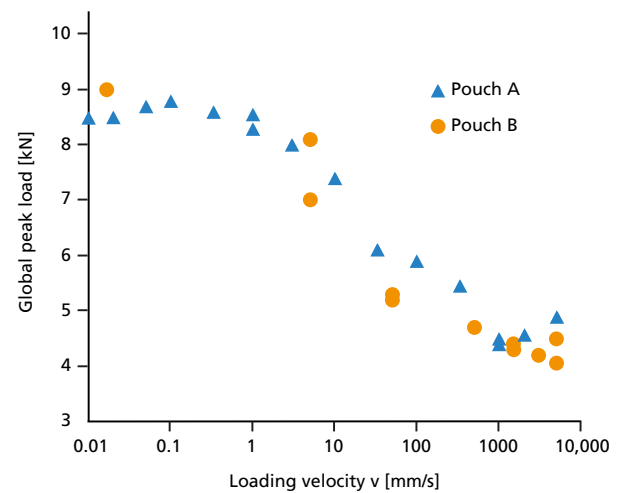

2 Critical force at cell intrusion as a function of loading velocity for two different pouch cells.



Contact

Dr. Thomas Kisters

thomas.kisters@emi.fraunhofer.de

Human models instead of dummies – new methods of occupant protection in crash simulations

The focus of crash research is not limited to materials but, of course, also includes the human body, which needs to be protected in any of the diverse possible crash scenarios. The modeling of the human body for crash tests is a new trend in the automotive industry. Physics, engineering, medicine and biology are combined in an interdisciplinary research field. The modeling of the human anatomy and the variations thereof in regards to height, weight and sex is of great interest along with descriptions of musculature and its active maneuverability. The muscular system has a proven large influence on how vehicle occupants react directly before a crash and on how the body behaves during a crash. There are severe differences compared to stiff and kinematically limited crash-test dummies, especially when the conditions of a standard test are minimally modified. Particular, in the content autonomous driving and the resulting new possible designs of the inner compartments of cars, it is important to rethink and possibly reevaluate current concepts concerning restraint systems. For this, active human modeling is a valuable and important tool.

The first crash scenarios were successfully computed and assessed with respect to occupant protection at EMI with the active human model THUMS™ v5.01. A current master thesis is examining the modeling of muscles in active human models.



Contact

Dr. Matthias Boljen

matthias.boljen@emi.fraunhofer.de

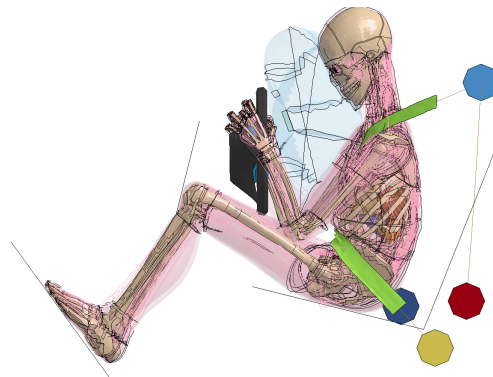

1 Frontal crash in tensed-muscle scenario of THUMS™ v5.01. The THUMS holds on to the steering wheel with active muscle contraction and braces itself during impact, which may disencumber the ribcage. The colored octahedrons visualize the different anchor points of the modeled safety belt.

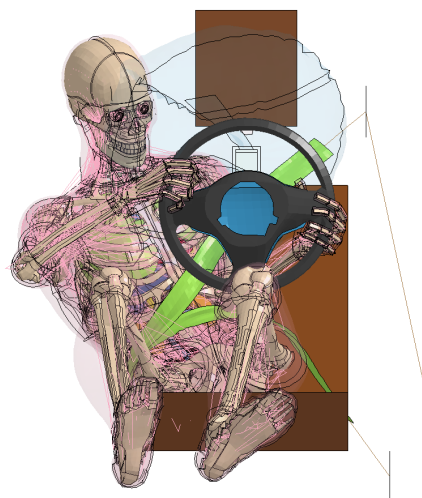

2 Offset crash in tensed-muscle scenario of THUMS™ v5.01. Possible challenges to the passive safety in a scenario deviating from a frontal crash become clear: The safety belt slips off.

Data analysis for objective suitability assessment of hybrid material systems in crash-loaded vehicle structures

Hybrid material systems made of fiber-reinforced plastics and conventional bodywork materials allow for the design of customized structure concepts. In light of the steadily increasing requirements in the fields of sustainable mobility, cost efficiency and crash functionality, these materials are gaining significance. In addition to the experimental analysis of crash behavior and qualification of numerical design methods, dependable suitability assessment methods and selection routines of corresponding material systems are required. A large part of established approaches for material selection is based upon the understanding of subjective user or expert knowledge for the multi-criteria decision-making. This in turn affects the reproducibility and the transparency of the processes.

A new methodology of load analysis uses the layered results of multiple full-vehicle crash simulations and other physics-based suitability criteria in order to obtain an objective suitability assessment for different hybrid systems in a structure application under considered load conditions. An analysis tool creates global load profiles of target structures through layering simulation results and a comparison with defined suitability criteria. These criteria are based upon the function (in this case, the crash) and the characteristics of the assessed material system (for example, anisotropy of mechanical characteristics). Furthermore, the new type of visualization of such load profiles in the bodywork allows for the identification of structure roles (for example, load paths) in the crash management of conventional vehicle architectures.

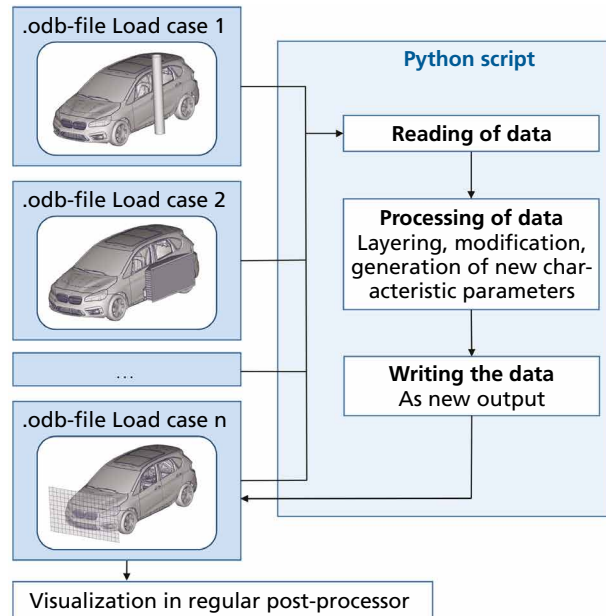

1 Information flow of the data analysis for the creation of a global load profile and visualization thereof.

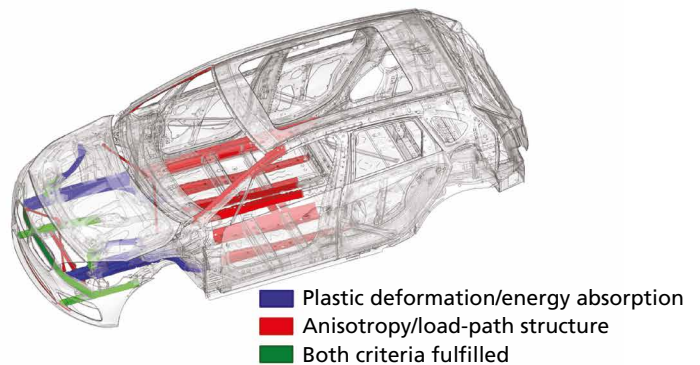

2 Identification and visualization of structure roles based upon the suitability criteria "load anisotropy" and "equivalent plastic deformation".



Contact

Dr. Michael Dlugosch

michael.dlugosch@emi.fraunhofer.de

BUSINESS UNIT
SPACE

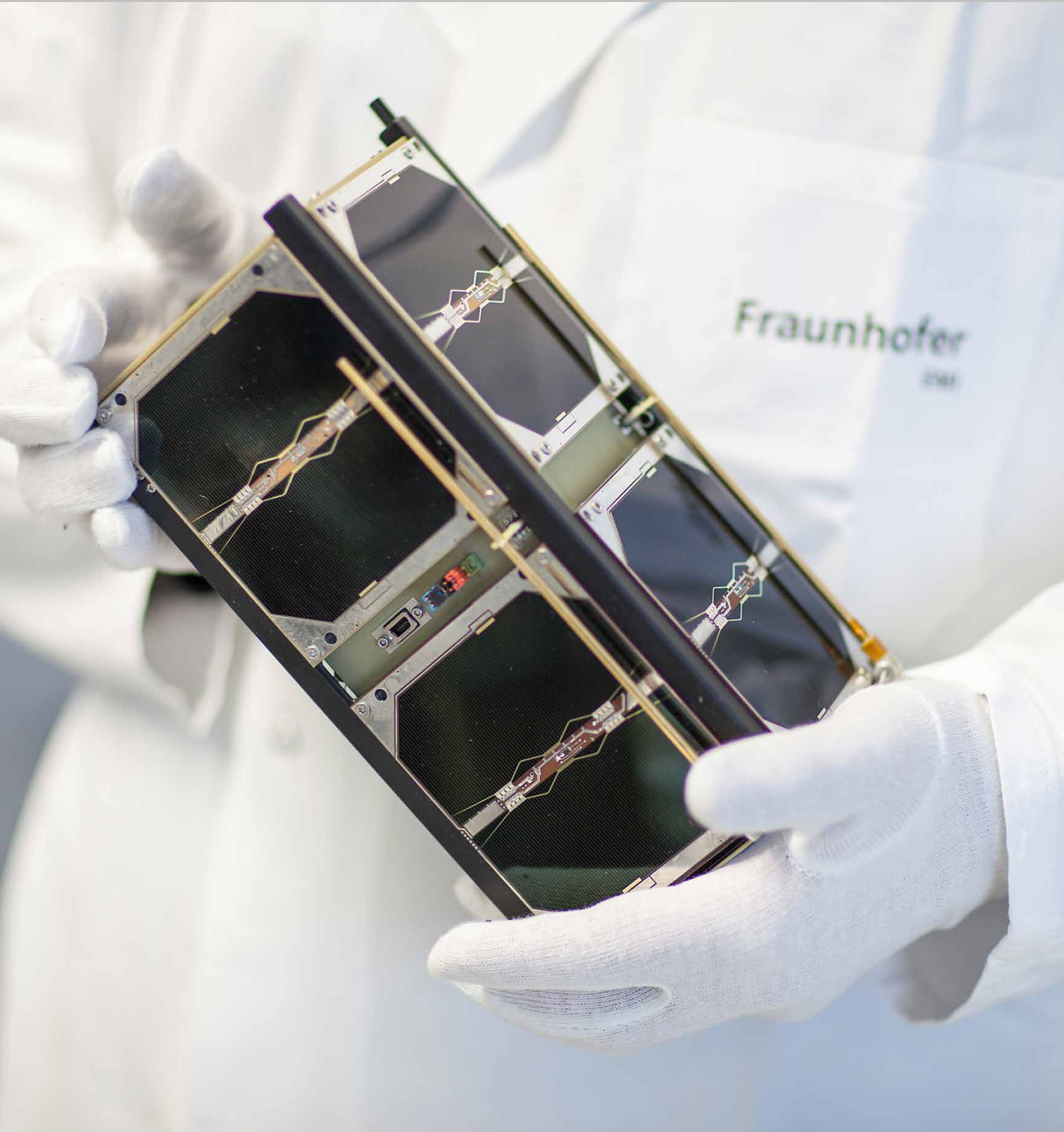

Fraunhofer
IME

BUSINESS UNIT SPACE

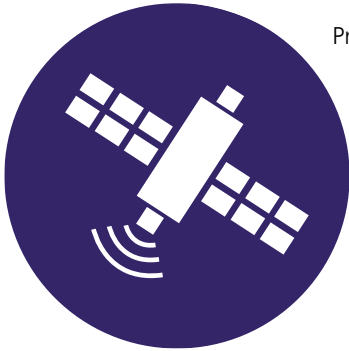

Private companies started to open up space with new business models. This trend is called “New Space” and “Space 4.0”. The companies use less reliable but the latest generation of components for innovative systems that are tested while in operation. This design philosophy of “trial and error” accepts the risk of the failure of components in order to take advantage of quick access to the market and short innovation cycles.

Simultaneously, the ongoing miniaturization and performance improvement of digital systems has fostered the development of small satellite systems with masses below 100 kilograms. Ambitious applications could already be demonstrated in the category of nanosatellites with masses of up to about 10 kilograms and small microsatellites with masses of up to 100 kilograms, for example, for monitoring ships by the automatic identification system (AIS) or for Earth observation in the visible spectral range.

Photo: 2-unit engineering model of a nanosatellite. EMI is working on its own nanosatellite and develops hardware and software for satellites.

The developments in Space 4.0 also raise new challenges for the business unit Space. The extreme volume and mass constraints in small satellite systems require new solutions, for example, for thermal management and vibration isolation.

For the German Federal Ministry of Defence (BMVg), we examine the potential of microsatellites to support the armed forces. We demonstrate this feasibility with a scientific infrared camera payload on the nanosatellite demonstrator ERNST, which weighs 15 kilograms. ERNST stands for: Experimentelle Raumfahrtanwendung basierend auf Nanosatellitentechnologie; experimental space application based on nanosatellite technology. With ERNST, we also offer new solutions that emerge with the 3D printing of metal structures.

Likewise, we highlight our research on new sensor technologies in the field of planetary sciences. With our sampling device for extracting asteroid material D-MEN, we have created another example of the efficient application of 3D printing of metallic structures in space engineering. Moreover, we report on a novel laser light sheet measurement technique as a method to capture complex fragment distributions.



Prof. Dr. Frank Schäfer
Head of business unit Space
Phone +49 761 2714-421
frank.schaefer@emi.fraunhofer.de

D-MEN: extraction of material samples from asteroids

The asteroids and comets in today's solar system are remnants of the material from which our planets were formed, the so-called planetesimals. The gravitation of the gas giants, above all Jupiter, has presumably inhibited the merging of these planetesimals in the vicinity of their sphere of influence. Instead, the asteroid belt formed between Mars and Jupiter as well as the Kuiper belt and the Oort cloud beyond the orbital path of Neptune. Some of these objects collide with planets in their orbit around the sun, as is verified by numerous impact craters. The effects of such impacts are examined at Fraunhofer EMI. Asteroid and comet impacts have characterized the history of life on Earth. On the one hand, they can dramatically influence environmental conditions, as did, for example, the Chicxulub asteroid impact, which might have led to the extinction of dinosaurs and a large part of the Mesozoic fauna and flora 66 million years ago. On the other hand, it is argued that such events led to the creation of life on Earth – the introduction of ice and primal building blocks of biomolecules to the Earth's surface may be linked back to asteroids. Asteroids and comets thus offer important, fundamental insights into the genesis of our solar system but elude simple examinations.

In the past few years, the so-called sample return missions have experienced increasing attention. In a sample return mission, material samples are extracted from a near-Earth object and brought back to Earth. The material can then be analyzed in a lab more thoroughly, reliably and accurately than is possible with remote sensing or instrumentation onboard a spacecraft. Just a few grams of intact, centimeter-sized material are sufficient to analyze the mineralogical and elemental composition as well as the biochemistry of the material. The last successful sample return mission with above described sample amounts dates back to the Soviet Luna missions in the 1970s. Currently, two such missions have been launched. The Japanese Hayabusa 2 is expected to shoot an impactor onto the surface of the Ryugu asteroid in order to capture ejected material. The NASA mission OSIRIS-REx deploys a gas stream to collect bulk material after landing on the asteroid Benu.

Within the scope of the project NEOShield-2, led by Airbus Defence and Space in Friedrichshafen, Germany, Fraunhofer EMI has developed a device for the extraction of material from asteroids and comets. The system is named D-MEN, short for Device for Material Extraction from Near Earth Objects. The construction of D-MEN was driven by the requirement of not only being able to collect loose particles but also to extract material from solid asteroid surfaces having compressive strength of up to 50 megapascals, such as in the case of sandstone. At least 100 grams of material with particle sizes of up to 3 centimeters are planned to be stored in a cylindrical volume with a diameter of 150 millimeters and a height of 130 millimeters. This volume includes the D-MEN device itself, which is integrated into a return capsule after the material extraction for the return flight and landing on Earth.

D-MEN combines two functional elements: the pyrotechnically driven impactors for material extraction and a bed fluidization system for material collection. This system is, as shown in Figure 1, integrated in the cylindrical element (gray).

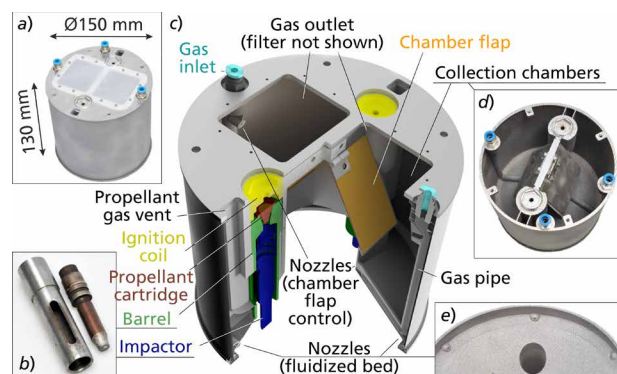

1 Structure and components of D-MEN: a) full view with dimensions, b) barrel and impactor, dismantled after testing, c) sectional view of functional elements, d) collection chambers in top view with dismantled lid, e) jets on the underside to create bed fluidization inside D-MEN. An animation of this operation can be found on our website:

www.emi.fraunhofer.de



2 Performance test with D-MEN: a) material extraction at a slanted angle in a test chamber, b) extracted material, c) collected material.

Pressurized gas flows from the gas ports (light blue) on the upper side through the D-MEN structure to the lower rim. Nozzles on the inside surface of the D-MEN create an upwards flowing gas stream, which entrains loose particles and transports them to the openings (orange) of the two collection chambers. The cover flaps of the chambers are opened by the gas stream. Dedicated nozzles can open specific chambers individually and fill them with material. This permits the distinction between collected surface material of the first collection process and the extracted material originating from a lower level of the second collection process. The impactors (blue) are initiated for the extraction of material. After the electro-thermic ignition of a propellant capsule, a hot gas expands in the barrel (green) and drives the impactor towards the asteroid surface. The impactor juts out from the barrel but stays within it in order to prevent contamination of the material samples. At the same time, propellant gas leaks upwards as a recoil compensation. The end of the impactor thrusts onto the material with a velocity of 55 meters per second and thus breaks off large pieces, which are then swept into a second chamber via a second gas stream process.

D-MEN is a highly integrated system, the structure of which was created in one piece via 3D metal printing at EMI, including all gas pipes and nozzles. The functional volume of the collection chambers could thereby be optimized to 472 cubic centimeters. The bottom rim contains structures to which particles are supposed to adhere if the sample extraction should fail. The impactors for material extraction are designed to be redundant.

The D-MEN design was optimized in extensive developmental tests, especially in terms of gas flow and the shape of the impactors. In order to take different asteroid qualities into account, the impactors demonstrated effective extraction of sandstone, tuff and aerated concrete in performance tests. In order to simulate the asteroid microgravity, lightweight plastic particles were used for testing the collection process. Even with Earth's gravitational pull, a significant amount of the extracted rocks could be successfully collected. All design requirements were met and a technological maturity level of 4 to 5 was reached. With the development of D-MEN, European space missions are now provided with a system for the extraction of asteroid material that have not been influenced by surface or cosmic ray effects.



3 Various developmental models of D-MEN.



Contact

Dr. Martin Schimmerohn

martin.schimmerohn@emi.fraunhofer.de

Thermal analysis for satellites exemplified by ERNST

The growing interest in small satellites is increasingly influencing and pushing scientific and technological developments in spacecraft technology research to an unprecedented degree. Current mission concepts for single satellites and satellite constellations are also increasingly becoming attractive for a steadily broadening spectrum of civil and military, planetary and interplanetary applications.

The temperature management of the energetically increasingly demanding and complex payloads is a great challenge for the expansion of the functionality of small satellites. To this end, a multi-disciplinary method was developed at Fraunhofer EMI and tested on the nanosatellite ERNST. In this method, a highly flexible, surface-based thermal analysis approach simulates thermal loads and localizes potential hazards that may occur during a mission (Figure 1). With the additional implementation of additive manufacturing technology, appropriate topologically optimized components, such as, for example, a radiator, can be designed and produced in order to efficiently dissipate the resulting thermal loads (Figure 2).

The high performance and adaptation capabilities of this approach can ideally adjust to the drastically decreasing development time spans and resources of small-scale satellite missions and contribute enormously to the current spacecraft technology revolution.

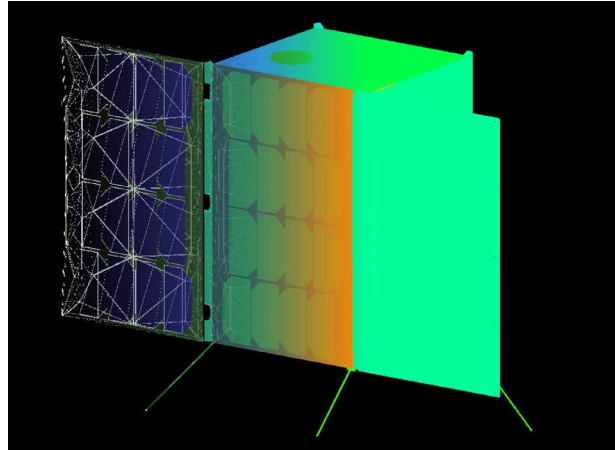

1 For thermal analysis, the 3-dimensional model of the nanosatellite ERNST was broken down into its surfaces.

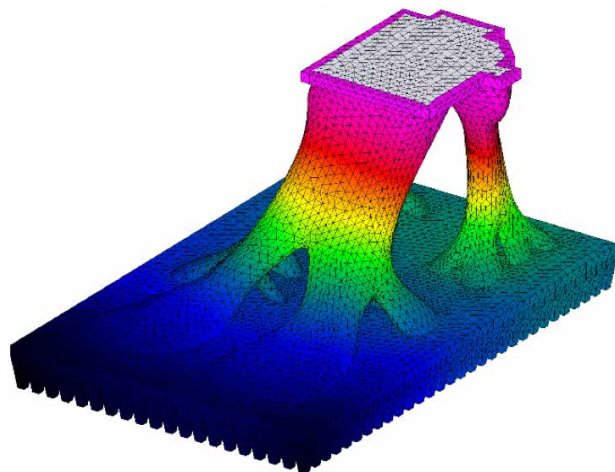

2 Temperature gradients can be minimized via a topologically optimized approach in the design of a radiator in order to efficiently dissipate excess thermal energy.



Contact

Dr. Max Gulde

max.gulde@emi.fraunhofer.de

Measurement of ejecta characteristics and impulse transfer in experiments on asteroid deflection

The astronomical observation of objects that are on a possible collision course with Earth has been significantly expanded in the last few years. If a timely recognition of a dangerous asteroid is successful, defensive measures for its deflection can be implemented. Alternative to the controversial deployment of nuclear warheads, the so-called kinetic deflection is an effective measure to deter asteroids from their collision course. It is not only the direct impulse transfer of the impactor but also the ejecta from the impact area itself which act like a rocket motor and directly increase the total impulse on the asteroid.

Fraunhofer EMI has contributed to the experimental characterization of ejecta and impulse transfer in geological materials through projects such as MEMIN and NEOShield. Currently, laser light sheet techniques are being optimized in which single ejecta particles are illuminated and their characteristics such as form, size and velocity vector can be traced. In a current measurement, this laser light sheet technique has been combined with impulse determination via a ballistic pendulum. Thereby, it is possible to exemplarily quantify the contribution of the fast ejecta particles to the total impulse. Such experimental data are essential for the validation of numerical simulations of kinetic asteroid deflection.

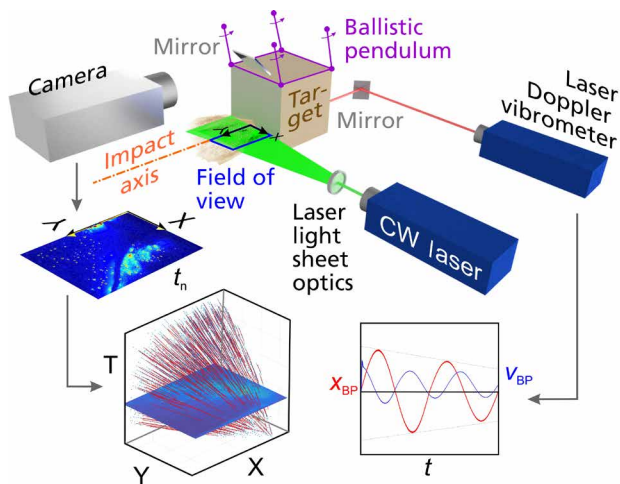

1 Illustration of the experimental setup for the simultaneous examination and correlation of ejecta characteristics and impulse transfer.

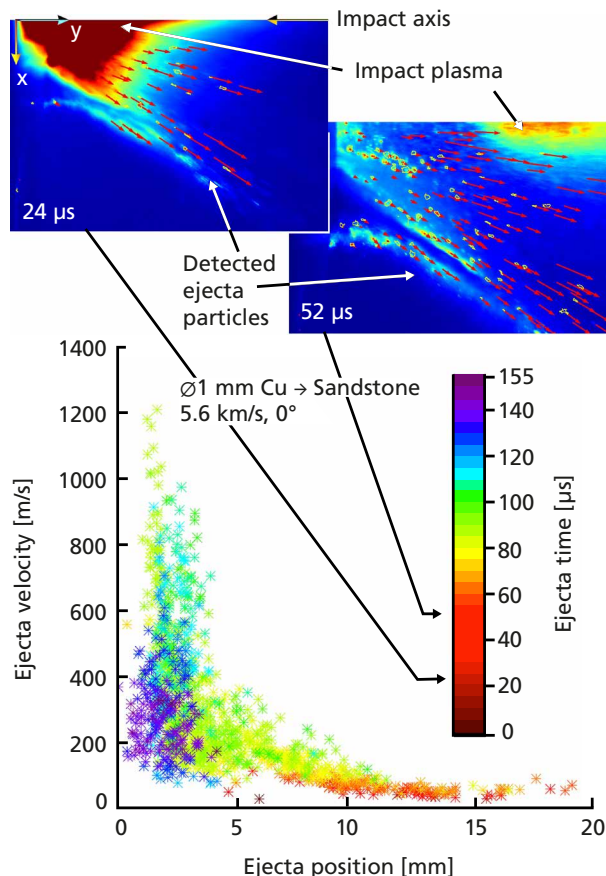

2 Temporally resolved velocity and position data of detected ejecta particles and exemplary sections of the high-speed recordings illuminated by laser light sheet.



Contact

Dr. Martin Schimmerohn

martin.schimmerohn@emi.fraunhofer.de

BUSINESS UNIT
AVIATION



BUSINESS UNIT AVIATION



The impact by foreign objects plays a significant role in the safety assessment of aircraft. There are more than ten thousands of collisions between birds and aircraft every year, which cause a total damage in the

order of one billion dollars. At Fraunhofer EMI, we examine these potentially dangerous collisions with scientific methods and consult our partners from the aviation industry concerning the design of structures that may be impacted by birds. The first article describes a simulation-based bird-strike assessment of the high-speed helicopter "Racer", which is currently being developed within the large European research program Clean Sky 2. The simulation-based bird-strike analyses performed by Fraunhofer EMI help to identify potentially vulnerable components at an early stage of the design process. The suggestions for improvement given by Fraunhofer EMI have therefore provided valuable input to the design of this novel rotorcraft.

The second article describes a completely new field of research. The increasing number of private and commercial drones leads to more dangerous encounters in airspace. Modern drones incorporate many components which, in contrast to a bird, do not behave like a fluid during collision with an aircraft. It is therefore expected that a collision with a drone causes more damage than a collision with a bird of the same mass. In the future, EMI will therefore increasingly investigate collisions between drones and aircraft.

Additionally, aircraft can be damaged by the force of nature, for example, by lightning strike or hailstones. Current investigations at Fraunhofer EMI will foster a better understanding of the interaction of hailstones and aircraft. Preliminary results are summarized in the corresponding article in this annual report.

Photo: Mechanical material characterization: CFRP sample after high-rate tensile test.



Dr. Michael May

Head of business unit Aviation

Phone +49 761 2714-337

michael.may@emi.fraunhofer.de

Bird-strike simulations for the new high-speed helicopter “Racer”

At the Paris Airshow, Airbus Helicopters presented a model of its new high-speed helicopter “Racer” on June 20, 2017 (Figure 1). The demonstrator developed within the EU aviation research program Clean Sky 2 is scheduled for its first flight in 2020. Racer, which is short for Rapid And Cost-Effective Rotorcraft, will incorporate several innovative features such as a high range and a high cruising speed of more than 400 kilometers per hour, and at the same time very low fuel consumption. This new type of helicopter is supposed to be deployed for search and rescue missions, emergency medical services as well as public and private supply and transportation flights.

Fraunhofer EMI provides basis for flight permit

The helicopter needs to comply with the requirements specified in the EASA standard CS-29 in order to receive a flight permit for its maiden flight in 2020. Amongst other things, it has to be demonstrated that a safe continuation of flight or a safe landing is possible after collision with a bird of a mass of one kilogram. Statistical data substantiate the necessity of this: Every year, several 10,000 collisions of birds with aircraft occur world-wide. They cause high economic losses and can sometimes even lead to safety risks. For example, the New York incident in 2009, when an A320 had to carry out an emergency landing on the Hudson River. Because of the low flight level, helicopters are highly susceptible to bird strikes. Fraunhofer EMI performed the simulations necessary to provide the proof of bird-strike resistance. Airbus Helicopters provided the relevant data, and based on these, a finite-element model (FE model) of Racer was generated. Using this model, bird strikes were simulated at various locations of the helicopter. The consequences of such impacts were subsequently analyzed.



Contact

Thomas Haase

thomas.haase@emi.fraunhofer.de



1 The new high-speed helicopter Racer. © Airbus Helicopters

Set up of the numerical model

For realistic simulations of bird-strike impact, a validated model of a bird had to be created. This happened in a simplified manner as the exact numerical reproduction of the animal would have been a quite considerable effort. Furthermore, details of the bird body only play a minor role for damages caused by impact. That is why birds are usually modeled as simple geometrical shapes such as spheres or ellipsoids. For the simulation performed at EMI, the frequently used cylinder with semispherical ends was utilized. The bird model was discretized by the SPH method (smoothed particle hydrodynamics). Given the high deformations occurring during an impact event, this method is superior to classical FE methods with regard to stability and computing time. When subjected to high velocities relevant during a bird-strike event, the material strengths are exceeded by far implying that the material can be modeled by assuming properties of a simple fluid such as water.

To validate the generated bird model, in a first step, open-access data published by the Air Force Materials Laboratory during the 1970s were used. Experiments in those times included real chickens as well as surrogate bodies made of gelatin impacting on a steel plate, where the occurring pressures were measured. In a second step, Airbus Helicopters supplied EMI with recent measurements. In this case, gelatin birds were shot against polycarbonate plates.

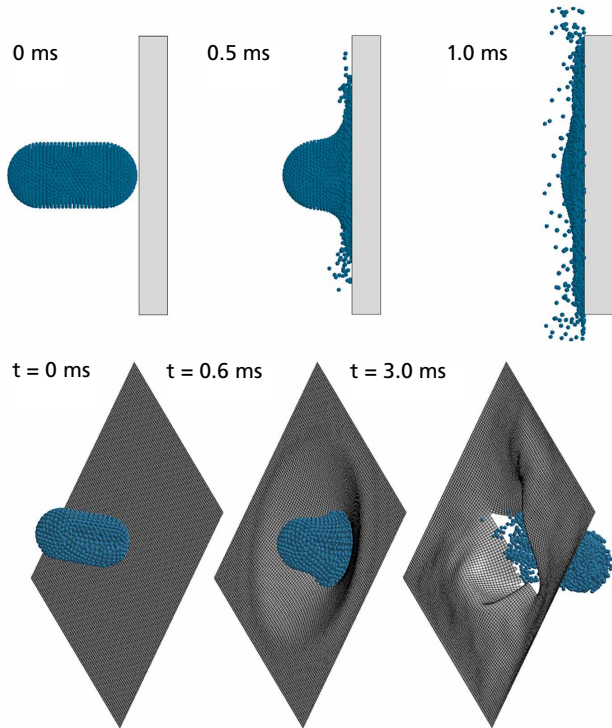

2 Simulation of a bird impacting onto a steel plate (top) and a polycarbonate plate (bottom) for the validation of the SPH (smoothed particle hydrodynamics) bird model.

Both types of experiment were simulated with the bird model (Figure 2: top: steel plate; bottom: polycarbonate plate). The computed pressures, forces and damages show high agreement with the experimental data.

Next, the FE model of the helicopter was generated. For this sake, geometric data were cleaned up, simplified, connected and subsequently discretized. Then, the materials involved were modeled and the composite layup, the contacts and the boundary conditions were defined. In its final version, the FE model of Racer consists of more than half a million shell and hexahedron elements. In spite of this large number of elements, the simulation of one bird strike requires only a computing time of about one to two hours on 16 CPUs (central processing units).

Evaluation of bird-strike resistance

The validated models were used to perform virtual bird-strike analyses for Racer high-speed motorcraft. Figure 3 shows, for example, the deformation of a polycarbonate windshield at collision and subsequent sliding-off of a bird

with a relative velocity of approximately 410 kilometers per hour. Despite strong deformation, the windshield stays intact.

The big advantage of using simulations is that it is easily possible to carry out modifications on the computer with respect to materials, wall thickness of components or change of impact location and velocity of the bird. Thus, various scenarios could be analyzed with regard to bird-strike resistance. Evaluation criteria included, for example, the potential perforation or breaking of components, the number of damaged layers of composites, the potential failure of adhesive layers or the residual velocity and the deflection of the bird towards critical structures. These analyses are essential for the preliminary design of the new helicopter. Fraunhofer EMI was able to identify vulnerable components and make suggestions for improvements. Thus, the work completed by EMI is a valuable contribution to the development process of Racer and serves Airbus Helicopters to prove that Racer fulfills the requirements for the flight permit.

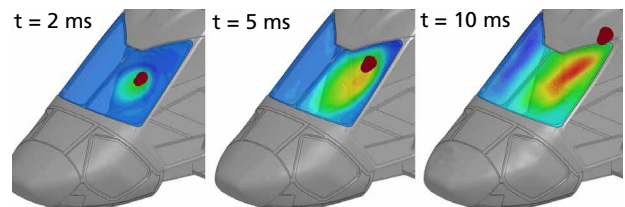

3 Simulation of a bird colliding with a polycarbonate windshield at 410 kilometers per hour. In the red area, the shield deforms up to 17 centimeters without breaking.

For further information, visit www.airbus.com



This project has received funding from the Clean Sky 2 Joint Undertaking under the European Union's Horizon 2020 research and innovation programme under grant agreement No. CS2-AIR-GAM-2016-2017-05.

Drone strike: analysis of aircraft safety during collisions with unmanned aerial vehicles

The number of unmanned aerial vehicles – also known as drones – operated privately and commercially has rapidly increased in the last years. Accordingly, the number of reported near-collisions between drones and commercial aircraft has also steadily increased, as both classes of aircraft share the same air space. The first actual collision occurred at the end of 2017 and thankfully did not result in any personal injuries. It is expected, however, that a collision with a drone will result in different damages to aircraft structures compared to a collision with a bird. While the tolerance of aircraft to bird strike needs to comply with standardized tests, there are currently no regulations for safety standards for a collision with a drone.

In order to develop the basis for the standardization of such tests, Fraunhofer EMI is planning a test bench with which drone components with high damaging potential (particularly the motors and batteries) will be accelerated to typical relative velocities, thus mimicking a collision with aircraft structures. This test bench allows not only for the evaluation of damages caused in aircraft components by impact of drone components but also for the determination of material parameters for the modeling as well as the development of numerical methods, both of which the aircraft industry could use for the assessment of risk potentials of a drone collision.



Contact

Dr. Sebastian Schopferer

sebastian.schopferer@emi.fraunhofer.de



1 No-fly-zone for drones in the vicinity helicopter operations.



2 Typical lithium ion battery (with a mass of approximately 700 grams) as it is used in a drone.

Ice impact on aircraft structures

Severe weather conditions may impose critical load scenarios for air traffic. If flying through a low-pressure area remains the only option for a pilot, hail impact can pose a threat to the aircraft and the passengers (Figure 1). Within the framework of Clean Sky 2, Fraunhofer EMI develops methods that allow considering these threats already during the engineering design by means of numerical simulations.

Profound knowledge about the characteristics of the hailstone is required in order to predict the structure damage in case of hail impact. The behavior of ice strongly depends on temperature and strain rate. Therefore, ice properties were analyzed in standard compression tests at varying temperatures and loading velocities. Furthermore, impact tests in a velocity range of 60 meters per second and 300 meters per second were conducted. In a first step, ice spheres were shot at a force sensor in order to measure the properties of ice during impact (Figure 2). In a second step, plates made from typical aviation materials such as aluminum and carbon-fiber-reinforced plastics (CFRP) were impacted using ice spheres. The available data in the existing literature was significantly extended within a temperature and strain-rate range relevant to hail impact. These investigations form the basis for the development of advanced numerical simulation methods.



1 Plane after flying through a hailstorm.

© picture alliance/dpa

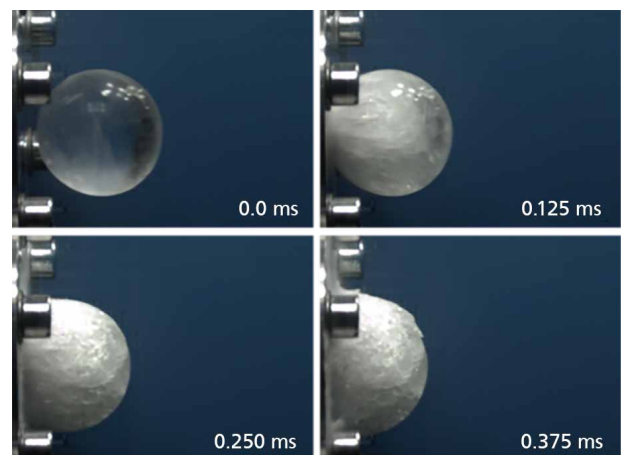

2 Ice sphere impacting onto a force sensor.



Contact

Dr. Michael May

michael.may@emi.fraunhofer.de



This project is funded
by the European Union

This project has received funding from the Clean Sky 2 Joint Undertaking under the European Union's Horizon 2020 research and innovation programme under grant agreement No. CS2-AIR-GAM-2016-2017-05.

SUSTAINABILITY
CENTER



HANNOVER, LOS ANGELES, NEW YORK AND MUNICH: SUSTAINABILITY CENTER FREIBURG PRESENTS LATEST INSIGHTS AROUND THE WORLD



As part of its core goal of collaborating with partners to find new solutions for sustainable development, the Sustainability Center Freiburg (LZN) presented its latest findings at numerous national and international events and was met with keen interest.

At the trade fair Hannover Messe, prominent representatives as EU Commissioner Günther Oettinger, Reinhard Bütikofer of the Green Party, and Fraunhofer President Reimund Neugebauer visited the LZN booth. Fraunhofer EMI scientists, in collaboration with Daimler AG, presented the anchor project "Tech Center i-protect", and X-ray car-crash technology. The bright orange Mercedes-Benz E-Class served as a unique eye-catcher.

The LZN was also able to showcase its competent work in matters of urban resilience beyond German borders throughout 2017. Researchers from the project TAURUS (based at Fraunhofer EMI) discussed their work at conferences, workshops, and meetings in Boston, Los Angeles, New Orleans, New York City, and Washington, D.C., with fellow experts from around the world.

At the end of its first funding period, the LZN was evaluated by Fraunhofer headquarters in late 2017. This evaluation was to be the basis of the decision on whether the LZN would receive support from the headquarters for the years 2019 and 2020. Due to a new agreement, the



1 The bright orange Mercedes-Benz E-Class served as a unique eye-catcher for the LZN at Hannover Messe 2017.

Fraunhofer High Performance Centers (of which LZN is an example of) are to be prospectively perpetuated post 2021.

In the transition period until then, the LZN aims to complete its goal of transferring scientific results to its industrial partners and the public by means of new projects and events. The LZN was positively evaluated in January 2018.

The various projects of the LZN, dealing with innovative solutions for great societal challenges, are a key factor in the success of the positive evaluation. The following reports provide insights into these projects that are currently being carried out by the LZN at Fraunhofer EMI.



Benjamin Scharte

Head of central office
Sustainability Center Freiburg
Phone +49 761 2714-538
benjamin.scharte@emi.fraunhofer.de

Photo: In the Sustainability Center Freiburg, solutions for a sustainable future are developed.

© Gettyimages

Bio-inspired, self-healing materials for a sustainable development

The ability of many plants to restore functionality through self-healing after damage would also be a highly attractive property for materials. Fraunhofer EMI, in collaboration with the botanical garden of the University of Freiburg, is assessing to what extent natural mechanisms can be applied to meet technical demands.

In order to describe the complex self-sealing mechanism, which is the first of two healing steps, a physical model of the plant *Delosperma cooperi* (Figure 1) was developed. Theories of poroelasticity, flows in porous bodies and diffusion were coupled in a continuum mechanics model. Since the shape and size of leaves vary greatly, a simplified, generic model leaf was created (Figure 1, right). Through the variation of different model parameters, it was possible to show in the simulations that the permeability and reflection coefficient of the cells are the determining parameters for the process of self-sealing. The mechanic parameters of the leaf have comparatively little influence. The precision of the modeled self-sealing process was verified by the comparison with experiments carried out on natural plant leaves (Figure 2).

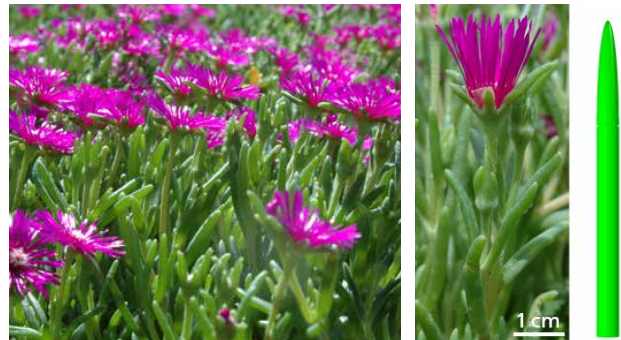

1 Left: flower bed of *Delosperma cooperi*. Center: single flower with petals and leaves. Right: model leaf for simulations.

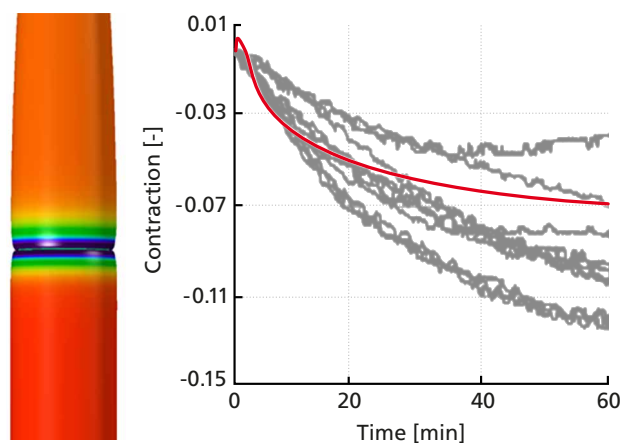

2 Left: reduction of exposed surface through contraction leading to reduced water loss. Right: comparison of contractions in damaged area in simulation (red) and experiment (gray).



Contact

Hartmut Klein

hartmut.klein@emi.fraunhofer.de

TAURUS – transatlantic progress in urban resilience research

TAURUS is an international research marketing project within the Sustainability Center Freiburg. It is funded by the initiative “Research in Germany – Land of Ideas” by the German Federal Ministry of Education Research (BMBF) and is part of the campaign “City of Tomorrow”.

Fraunhofer EMI is the project coordinator. The main objective of TAURUS is to increase the visibility of planning and process management solutions for urban resilience, developed by Fraunhofer EMI and the University of Freiburg within the Sustainability Center in the US. In addition, TAURUS aims at opening up new fields of research cooperation for Fraunhofer EMI. Its target region is the northeast megalopolis in the US with a special focus on the three cities Boston, MA, New York City, NY, and Washington, D.C.

Together with its partners, Northeastern University, the Stevens Institute of Technology and the National Academies of Sciences, Fraunhofer EMI developed the concept of a technology roadshow in the first half of 2017. The roadshow was held in Boston and New York from October 23 to 26, 2017, where Professor Stefan Hiermaier presented solutions for resilience in lectures and expert discussions.

In March 2018, the close network between Fraunhofer EMI and the Northeastern University lead to the foundation of a transatlantic research network for urban resilience, the “Global Resilience Research Network” (GRRN). This network is made up of different universities and research institutes from around the world. A digital platform called “Lynx-Net” enables virtual research collaboration and information sharing among the members of GRRN and connects the members with other relevant practitioners.



Contact

Daniel Hiller

daniel.hiller@emi.fraunhofer.de

For the future, an exchange program for students between Freiburg and Boston within the GRRN is planned. Moreover, the second Annual Global Resilience Research Network Summit will be hosted by Fraunhofer EMI in April 2019 in Freiburg, Germany.



1 The second Annual Global Resilience Research Network Summit will be hosted by Fraunhofer EMI from April 10 to 11, 2019, in Freiburg and will gather leading scientists engaged in resilience research.

Sustainability Center Freiburg (LZN)

The Sustainability Center is a strategic alliance between the University of Freiburg, the five Fraunhofer Institutes in Freiburg and several industrial partners. Together they work on the subject of sustainable development in an inter- and transdisciplinary way to develop innovative, sustainable products and services. To this end, Fraunhofer and the University of Freiburg also founded the Department of Sustainable Systems Engineering (INATECH) at the Faculty of Engineering at Freiburg University.

The Sustainability Center started out as a pilot for the high-performance center concept of the Fraunhofer-Gesellschaft. Since its opening in 2015, many others have followed.

For further information, visit www.leistungszentrum-nachhaltigkeit.de

Contact

Benjamin Scharte

benjamin.scharte@emi.fraunhofer.de

EMI MOSAIC

Applying science and sharing expertise – EMI scientists talk about teaching at INATECH



INATECH
DEPARTMENT OF SUSTAINABLE
SYSTEMS ENGINEERING

In 2015, the University of Freiburg and the five Fraunhofer Institutes in Freiburg founded the Department of Sustainable Systems Engineering (INATECH) at the university. It aims to combine academic teaching and research in the fields of sustainable systems within an engineering context. Professor Stefan Hiermaier, director of Fraunhofer EMI, is the founding director of INATECH. He wants

to foster the cooperation between academic teaching and the Fraunhofer Institutes and has filled several teaching positions with researchers from his Fraunhofer Institute. In this article, four scientists from Fraunhofer EMI talk about their experiences at INATECH and describe the synergies which occur during their work in science and teaching.

// To interact with students and other disciplines at INATECH introduces new aspects for my work at Fraunhofer EMI. Exchanging ideas with these young and motivated people is particularly inspiring. They often question well-established principles and make me consider many topics from another perspective. At the same time, my experience in science functions as a basis for my teaching. Nevertheless, planning the different lectures requires broadening my horizons and // keeping up to date – especially in the field of sustainability.



Dr. Alexander Stolz is head of business unit Security at EMI and lectures on “Design and Monitoring of Large Urban Infrastructures” and “Robustness of Structures: Resilient Designs” at INATECH.



// The knowledge about materials and their behavior from my work at EMI gives me a varied background to introduce the students to materials cycles. It is a great pleasure to teach such an interesting, political and current topic within an intercultural environment like INATECH. At the same time, teaching also inspires me and produces new ideas for my daily work at EMI. // It encourages me to open up new subject areas.

At Fraunhofer EMI, Dr. Sebastian Kilchert deals with materials and simulation methods within the group Composite Design. At INATECH, he gives a lecture on “Material Life Cycles”.



1 Professor Hiermaier during a lecture at the Department of Sustainable Systems Engineering (INATECH), University of Freiburg.



“ As INATECH is still very young, there is a nice enthusiastic spirit amongst students and faculty. Talking to our students for whom sustainability is an intrinsic value, I question many of our established routines at EMI. At EMI, contract research with the industry is one of our cornerstones. This implies an efficient and functional organizational structure. I want to establish // the same positive atmosphere at INATECH. // ”

Dr. Georg Ganzenmüller is group manager of Mashfree Methods at EMI. Moreover, he is manager of Professor Hiermaier's academic chair. His duties concern organizational and personnel matters as well as assisting Professor Hiermaier in his teaching.

“ Condensing EMI's complex research topics into lectures helps me in matters of project development and execution and specifies scientific concepts in a stimulating way. Students are also interested in the work-related applicability of knowledge. As a scientist I have this practical experience. Students often question supposedly established approaches and look towards the future. Thus, easier approaches or even completely new ideas may be discovered. Of course, another goal is to win over interested and well-prepared graduates as future // employees at EMI and to pass on the 'scientific fire'. // ”



Dr. Ivo Häring has been teaching resilience in different lectures, tutorials and university projects at INATECH since 2016. Moreover, he contributes to the chair's strategic process and designs its vision and mission. At EMI, he is deputy head of department Safety Technology and Protective Structures, his research focusing on resilience.

CELEBRATORY OPENING OF NEW EMI BUILDING



More space for applied research in the fields of aviation, space, car crash, defense and security research

November 30, 2017, was the big opening day of the new EMI building. After a construction period of two years, more than 100 guests gathered to celebrate the opening. The new building is home to five modern laboratories and 50 workplaces. Lightweight center, laser technology laboratory, sensor development and satellite research are finally all under the same roof. The five floors are connected through a piece of art called "Martians Stranded on Earth" by Jeronimo Voss. The installation art addresses thoughts of Ernst Mach and discusses the linearity of time.

The eight-million-euro construction was financed half-and-half by the German Federal Ministry of Education and Research (BMBF) and the State Ministry of Baden-Württemberg for Economic Affairs, Labour and Housing Construction. State minister Dr. Nicole Hoffmeister-Kraut praised Fraunhofer EMI in her addressing speech as a "worldwide leading institute for security and resilience research". Dr. Wolf-Hendrik Junker from the German Federal Ministry of Education and Research particularly emphasized the importance of attractive working conditions in research and development, which are provided by the new EMI building. Fraunhofer President Professor Reimund Neugebauer declared, "The new construction is a big investment in the regional innovation ecosystem. From aviation and space to automotive and security research:

With these new first-class laboratories, we ensure that we continuously expand and strengthen our offer concerning future relevant key technologies to our customers from the industry and the public sector."

Director of Fraunhofer EMI Professor Stefan Hiermaier also expressed his delight. Resource efficiency and the resilience of technical systems, which will be researched in the new laboratories, are two topics lying particularly close to his heart. These fields also build a bridge to the Faculty of Engineering of the University of Freiburg where Professor Stefan Hiermaier is the director of the Department of Sustainable Systems Engineering (INATECH).



1 The new building on Ernst-Zermelo-Strasse (left) next to the existing building (right).

Photo: The celebratory opening of the new EMI building in Freiburg. From left to right: Dr. Wolf-Hendrik Junker, under-secretary of the German Federal Ministry of Education and Research, Professor Reimund Neugebauer, president of the Fraunhofer-Gesellschaft, Dr. Nicole Hoffmeister-Kraut, state minister for Economic Affairs, Labour and Housing Construction of Baden-Württemberg, Professor Stefan Hiermaier, director of Fraunhofer EMI.

PROFILE OF
THE INSTITUTE

CONTACT PERSONS



Prof. Dr.-Ing. habil. Stefan Hiermaier

Director

Phone +49 761 2714-101

stefan.hiermaier@emi.fraunhofer.de



Dr. Tobias Leismann

Deputy director

Phone +49 761 2714-102

tobias.leismann@emi.fraunhofer.de



Prof. Dr. Frank Schäfer

Deputy director | Business unit Space

Phone +49 761 2714-421

frank.schaefer@emi.fraunhofer.de



Petra Gross

Administration

Phone +49 761 2714-115

petra.gross@emi.fraunhofer.de



Sarah Gnädinger

Advisor of the institute management | Event management

Phone +49 761 2714-100

sarah.gnaedinger@emi.fraunhofer.de



Daniel Hiller

Strategic Management

Phone +49 761 2714-488

daniel.hiller@emi.fraunhofer.de



Dr. Matthias Wickert

Business unit Defense

Phone +49 761 2714-384

matthias.wickert@emi.fraunhofer.de



Dr. Alexander Stolz

Business unit Safety

Phone +49 7628 9050-646

alexander.stolz@emi.fraunhofer.de



Dr. Jens Fritsch

Business unit Automotive

Phone +49 761 2714-472

jens.fritsch@emi.fraunhofer.de



Dr. Michael May

Business unit Aviation

Phone +49 761 2714-337

michael.may@emi.fraunhofer.de



Birgit Bindnagel

Press and Public Relations

Phone +49 761 2714-366

birgit.bindnagel@emi.fraunhofer.de

FACTS AND FIGURES

Finances

The total budget of Fraunhofer EMI amounted to 24.79 million euros and was slightly less than last year. 22.93 million euros of the total budget are allotted to the operating budget (staff costs and material costs) and 1.86 million euros to the investment budget. Fraunhofer EMI is being financed by external revenues from the industry, by public funding and by institutional base funding by

the German Federal Ministry of Defence (BMVg) and the German Federal Ministry of Education and Research (BMBF). 66 percent, the biggest share of the operating and investment budget, were financed by the German Federal Ministry of Defence in 2017. This year, the industrial revenues hit a record high of 40.8 percent.

Finances of the overall budget in million euros

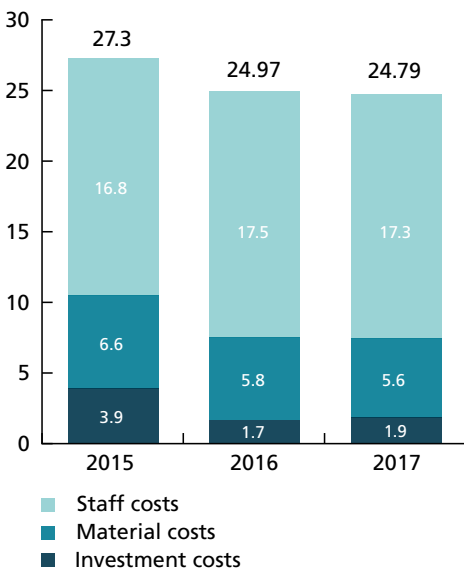

Finances overall budget in million euros

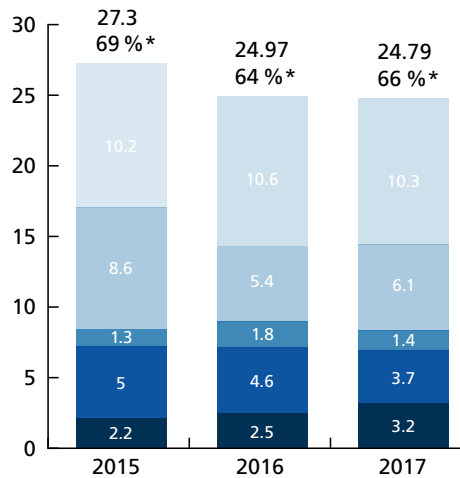

*Share by the German Federal Ministry of Defence (BMVg) (including secondary institutions)

- Base funding by the German Federal Ministry of Defence (including secondary institutions)
- Project funding by the German Federal Ministry of Defence (including secondary institutions)
- Civilian base funding
- German Federal Ministry of Education and Research, EU, others
- Industry

Staff structure

By the end of 2017, 317 people were employed at Fraunhofer EMI: 258 employees as permanent staff, 26 as apprentices and 33 as research assistants and interns. The amount of female employees increased to 25 percent. 224 of the 317 employees were directly involved in research, and 93 worked in the fields of infrastructure and management. Ten of the 26 apprentices worked in precision mechanics, eight in electronics and three in media design. Five employees worked at Fraunhofer EMI within the scope of their vocational training or their university studies at the Baden-Württemberg Cooperative State University (DHBW).

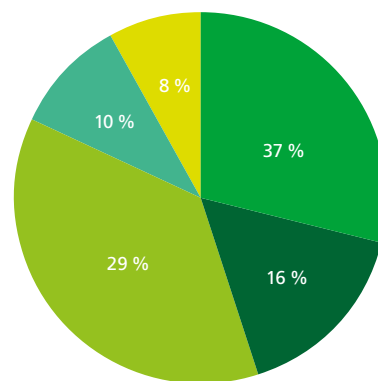

- Non-scientific staff in the research departments
- Scientific staff in the research departments
- Infrastructure and management
- Research assistants and interns
- Apprentices

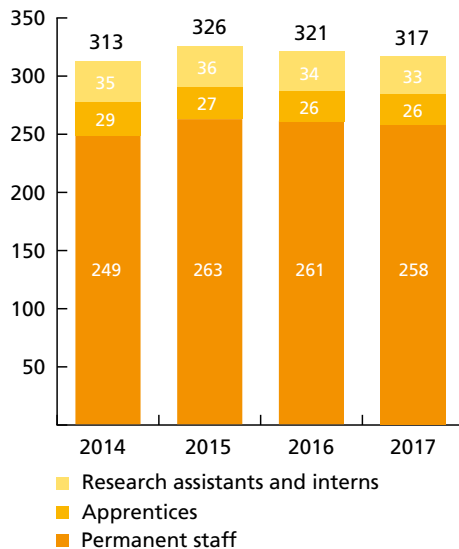

Contact

Petra Gross

petra.gross@emi.fraunhofer.de

ADVISORY BOARD

Fraunhofer-Institut für Kurzzeitdynamik
43. Sitzung des Kuratoriums

Freiburg, 21. Juli 2017



The advisory boards of the various Fraunhofer Institutes advise the directors of the institutes and the executive board of the Fraunhofer-Gesellschaft. It also enhances the institute's contacts to other organizations and to the industry.

Prof. Dr. rer. nat. Frank Gauterin
Director of the Institute for Vehicle Systems Technology,
KIT, Karlsruhe

Univ.-Prof. Dr.-Ing. habil. Norbert Gebbeken
Director of the Institute for Mechanics and Statics,
Universität der Bundeswehr München, Neubiberg

Dipl.-Ing. Thomas Gottschild (Chairman)
Managing Director of MBDA Deutschland GmbH,
Schrobenhausen

MinR'in Dr. rer. pol. Ehrentraud Graw
Head of Division 33: Automotive and Manufacturing
Industries, Logistics, Ministry of Economics, Employment
and Housing, Baden-Württemberg, Stuttgart

Rainer Hoffmann
Chief Executive Officer carhs.training GmbH, Alzenau

MinR Dr. Wolf-Hendrik Junker
Head of Division 522: Security Research, German Federal
Ministry of Education and Research (BMBF), Bonn

Prof. Dr. Gunther Neuhaus
Vice Rector and Vice President for Research,
University of Freiburg

Thorsten Puschmann
Brigadegeneral, Head of Division "Combat", Federal
Office of Bundeswehr Equipment, Information Technology
and In-Service Support (BAAiNBw), Koblenz

Prof. Dr. Wolf Uwe Reimold
Professor of Mineralogy and Petrography, Deputy Head
of the Research Department, Museum for Natural History,
Leibniz Institute for Evolution and Biodiversity Science,
Berlin

Dr. Tobias Schmidt
Head of Department and Head of Development at location
Unterlöss, Rheinmetall Waffe Munition GmbH, Unterlöss

Prof. Dr.-Ing. Rodolfo Schöneburg
Director Passive Vehicle Safety/Durability/Corrosion
Protection Mercedes Benz Cars, Daimler AG, Sindelfingen

Dr. Isabel Thielen
Management THIELEN Business Coaching GmbH, München

MinR Dipl.-Ing. Norbert Michael Weber
Head of Division A II 6, Federal Ministry of Defence, Bonn

Dr. Rolf Wirtz
Chief Executive Officer, ThyssenKrupp Marine Systems
GmbH, Kiel

*Photo: The EMI advisory
board at its meeting in July
2017.*

FRAUNHOFER-GESELLSCHAFT



Fraunhofer-Gesellschaft

Research of practical utility lies at the heart of all activities pursued by the Fraunhofer-Gesellschaft. Founded in 1949, the research organization undertakes applied research that drives economic development and serves the wider benefit of society. Its services are solicited by customers and contractual partners in industry, the service sector and public administration.

At present, the Fraunhofer-Gesellschaft maintains 72 institutes and research units. The majority of the more than 25 000 staff are qualified scientists and engineers, who work with an annual research budget of 2.3 billion euros. Of this sum, almost 2 billion euros are generated through contract research. Around 70 percent of the Fraunhofer-Gesellschaft's contract research revenue is derived from contracts with industry and from publicly financed research projects. Around 30 percent is contributed by the German federal and state governments in the form of base funding, enabling the institutes to work ahead on solutions to problems that will not become acutely relevant to industry and society until five or ten years from now.

International collaborations with excellent research partners and innovative companies around the world ensure direct access to regions of the greatest importance to present and future scientific progress and economic development.

With its clearly defined mission of application-oriented research and its focus on key technologies of relevance to the future, the Fraunhofer-Gesellschaft plays a prominent role in the German and European innovation process. Applied research has a knock-on effect that extends beyond the direct benefits perceived by the customer: Through their research and development work, the Fraunhofer Institutes help to reinforce the competitive strength of the economy in their local region, and throughout Germany and Europe. They do so by promoting innovation, strengthening the technological base, improving the acceptance of new technologies, and helping to train the urgently needed future generation of scientists and engineers.

As an employer, the Fraunhofer-Gesellschaft offers its staff the opportunity to develop the professional and personal skills that will allow them to take up positions of responsibility within their institute, at universities, in industry and in society. Students who choose to work on projects at the Fraunhofer Institutes have excellent prospects of starting and developing a career in industry by virtue of the practical training and experience they have acquired.

The Fraunhofer-Gesellschaft is a recognized non-profit organization that takes its name from Joseph von Fraunhofer (1787–1826), the illustrious Munich researcher, inventor and entrepreneur.

Photo: The headquarters of the Fraunhofer-Gesellschaft in Munich.



For further information, visit www.fraunhofer.de

PUBLICATIONS,
EDUCATIONAL ACTIVITIES,
SCIENTIFIC EXCHANGE
2017/2018

PUBLICATIONS

Publications in books, specialist journals and proceedings with peer review

Behner, T.; Heine, A.; Wickert, M. (2017): Extended investigation of the dwell effect for an unconfined silicon carbide ceramic against tungsten-heavy-alloy rods. In: S. Chocron und J. Walker (Hg.): Proceedings, Vol. 2. 30th International Symposium on Ballistics. Long Beach, CA, USA, 11.–15.9.2017. Lancaster, PA, USA: DEStech Publications, S. 2138–2147.

Cola, F. de; Pellegrino, A.; Glöbner, C.; Penumadu, D.; Petrinic, N. (2018): Effect of particle morphology, compaction, and confinement on the high strain rate behavior of sand. In: *Experimental Mechanics* 58 (2), S. 223–242. DOI: 10.1007/s11340-017-0331-x.

Denefeld, V.; Heider, N.; Holzwarth, A. (2017): Measurement of the spatial specific impulse distribution due to buried high explosive charge detonation. In: S. Chocron und J. Walker (Hg.): Proceedings, Vol. 2. 30th International Symposium on Ballistics. Long Beach, CA, USA, 11.–15.9.2017. Lancaster, PA, USA: DEStech Publications, S. 1547–1551.

Denefeld, V.; Heider, N.; Holzwarth, A. (2017): Measurement of the spatial specific impulse distribution due to buried high explosive charge detonation. In: *Defence Technology* 13 (3), S. 219–227. DOI: 10.1016/j.dt.2017.03.002.

Dlugosch, M.; Fritsch, J.; Lukaszewicz, D.; Hiermaier, S. (2017): Experimental investigation and evaluation of numerical modeling approaches for hybrid-FRP-steel sections under impact loading for the application in automotive crash-structures. In: *Composite Structures* 174, S. 338–347. DOI: 10.1016/j.compstruct.2017.04.077.

Dlugosch, M.; Spiegelhalter, B.; Soot, T.; Lukaszewicz, D.; Fritsch, J.; Hiermaier, S. (2017): Potentials of optical damage assessment techniques in automotive crash-concepts composed of FRP-steel hybrid material systems. In: *Journal of Physics: Conference Series* 842 (1), S. 12044. Online verfügbar unter <http://stacks.iop.org/1742-6596/842/i=1/a=012044>.

Dlugosch, M.; Volk, M.; Lukaszewicz, D.; Fritsch, J.; Hiermaier, S. (2017): Suitability assessments for advanced composite-metal hybrid material systems in automotive crash structural applications. In: *International Journal of Automotive Composites* 3 (1), S. 14. DOI: 10.1504/IJAU-TOC.2017.10007651.

Durr, N.; Sauer, M.; Hiermaier, S. (2017): A numerical study on mesoscale simulation of quartzite and sandstone under shock loading. In: *International Journal of Impact Engineering* 108, S. 73–88. DOI: 10.1016/j.ijimpeng.2017.04.008.

Früh, P.; Heine, A.; Riedel, W. (2017): Assessment of the protective properties of two different UHA steels based on material testing and numerical simulation. In: *Procedia Engineering* 197, S. 119–129. DOI: 10.1016/j.proeng.2017.08.088.

Früh, P.; Heine, A.; Riedel, W.; Wickert, M. (2017): Protection capabilities of HHA and UHA steels against long-rod kinetic energy penetrators. In: S. Chocron und J. Walker (Hg.): Proceedings, Vol. 2. 30th International Symposium on Ballistics. Long Beach, CA, USA, 11.–15.9.2017. Lancaster, PA, USA: DEStech Publications, S. 2357–2367.

Genzenmüller, G. C.; Blaum, E.; Mohrmann, D.; Langhof, T.; Plappert, D.; Ledford, N.; Paul, H.; Hiermaier, S. (2017): A simplified design for a Split-Hopkinson Tension Bar with long pulse duration. In: *Procedia Engineering* 197, S. 109–118. DOI: 10.1016/j.proeng.2017.08.087.

Glöbner, C.; Moser, S.; Külls, R.; Heß, S.; Nau, S.; Salk, M.; Penumadu, D.; Petrinic, N. (2017): Instrumented projectile penetration testing of granular materials. In: *Experimental Mechanics* 57 (2), S. 261–272. DOI: 10.1007/s11340-016-0228-0.

Grunwald, C.; Schaufelberger, B.; Stolz, A.; Riedel, W.; Borrvall, T. (2017): A general concrete model in hydrocodes. Verification and validation of the Riedel-Hiermaier-Thoma model in LS-DYNA. In: *International Journal of Protective Structures* 8 (1), S. 58–85. DOI: 10.1177/2041419617695977.

Gulde, M.; Berger, H.; Putzar, R. (2017): Stereoscopic imaging determines space debris impact crater distribution and morphology. In: *Aeronautics and Aerospace Open Access Journal* 1 (4), S. 1–5. DOI: 10.15406/aaaj.2017.01.00021.

Gulde, M.; Kortmann, L.; Ebert, M.; Watson, E.; Wilk, J.; Schäfer, F. (2017): Robust optical tracking of individual ejecta particles in hypervelocity impact experiments. In: *Meteoritics & Planetary Science* 108. DOI: 10.1111/maps.12958.

Häring, I.; Sansavini, G.; Bellini, E.; Martyn, N.; Kovalenko, T.; Kitsak, M.; Vogelbacher, G.; Ross, K.; Bergerhausen, U.; Barker, K.; Linkov, I. (2017): Towards a generic resilience management, quantification and development process: General definitions, requirements, methods, techniques and measures, and case studies. In: I. Linkov und J. Palma-Oliveira (Hg.): *Resilience and Risk*. Dordrecht: Springer (NATO Science for Peace and Security Series C: Environmental Security), S. 21–80.

Heider, N.; Steinbrenner, A.; Aurich, H. (2017): A method for the determination of the viscoelastic relaxation modulus of PBX by confined SHPB measurements. In: *Journal of Dynamic Behavior of Materials* 3 (1), S. 133–150. DOI: 10.1007/s40870-017-0100-z.

Heimbs, S.; Jürgens, M.; Breu, C.; Ganzenmüller, G. C.; Wolfrum, J. (2017): Investigation and improvement of composite T-joints with metallic ar-row-pin reinforcement. In: G. L. Cloud, E. Patterson und D. Backman (Hg.): *Joining Technologies for Composites and Dissimilar Materials, Volume 10: Proceedings of the 2016 Annual Conference on Experimental and Applied Mechanics*. Cham: Springer International Publishing, S. 33–40.

Hoerth, T.; Bagusat, F.; Hiermaier, S. (2017): Hugoniot data of Seeberger sandstone up to 7 GPa. In: *International Journal of Impact Engineering* 99, S. 122–130. DOI: 10.1016/j.ijimpeng.2016.08.003.

Isakov, M.; Matikainen, V.; Koivuluoto, H.; May, M. (2017): Systematic analysis of coating-substrate interactions in the presence of flow localization. In: *Surface and Coatings Technology* 324, S. 264–280. DOI: 10.1016/j.surfcoat.2017.05.040.

Kisters, T.; Sahraei, E.; Wierzbicki, T. (2017): Dynamic impact tests on lithium-ion cells. In: *International Journal of Impact Engineering* 108, S. 205–216. DOI: 10.1016/j.ijimpeng.2017.04.025.

Krag, H.; Serrano, M.; Braun, V.; Kuchynka, P.; Catania, M.; Siminski, J.; Schimmerohn, M.; Marc, X.; Kuijper, D.; Shurmer, I.; O'Connell, A.; Otten, M.; Muñoz, I.; Morales, J.; Wermuth, M.; McKissock, D. (2017): A 1 cm space debris impact onto the Sentinel-1A solar array. In: *Acta Astronautica* 137, S. 434–443. DOI: 10.1016/j.actaastro.2017.05.010.

Lässig, T.; Bagusat, F.; Pfänder, S.; Gulde, M.; Heunoske, D.; Osterholz, J.; Stein, W.; Nahme, H.; May, M. (2017): Investigations on the spall and delamination behavior of UHMWPE composites. In: *Composite Structures* 182, S. 590–597. DOI: 10.1016/j.compstruct.2017.09.031.

May, M.; Lässig, T. (2017): Rate-dependent mode I delamination in ballistic composites – Experiment and simulation. In: *Composite Structures* 180, S. 596–605. DOI: 10.1016/j.compstruct.2017.08.045.

Mühlstädt, M.; Seifert, W.; Arras, M. M. L.; Maenz, S.; Jandt, K. D.; Bossert, J. (2017): 3D model of intra-yarn fiber volume fraction gradients of woven fabrics. In: *Composite Structures* 180, S. 944–954. DOI: 10.1016/j.compstruct.2017.08.049.

- Osterholz, J.; Heunoske, D.; Horak, J.; Lexow, B.; Lück, M.; Schäffer, S.; Wickert, M. (2017): Experimental characterization of energy transfer from large-diameter kilowatt continuous-wave laser beams to metal samples. In: *Journal of Laser Applications* 29 (1), S. 12011. DOI: 10.2351/1.4972099.
- Pfaff, A.; Jäcklein, M.; Hoshcke, K.; Wickert, M. (2017): Designed Materials by Additive Manufacturing – impact of exposure strategies and -parameters on material characteristics of AISi10Mg processed by Selective Laser Melting. In: *Proceedings of the 2nd International Conference on Light Materials – Science and Technology (LightMAT 2017)*. Bremen, Germany, 8.–10.11.2017.
- Ramin, M. von; Stolz, A. (2017): Klassifizierung von Gebäudeschäden infolge seismischer Beanspruchung. In: V. Zabel und S. Beinersdorf (Hg.): *Tagungsband 15. D-A-C-H-Tagung Bauhaus Universität Weimar: Erdbebeningenieurwesen und Baudynamik*, 21.–22.9.2017, S. 146–155.
- Sauer, C.; Heine, A.; Riedel, W. (2017): Developing a validated hydrocode model for adobe under impact loading. In: *International Journal of Impact Engineering* 104, S. 164–176. DOI: 10.1016/j.ijimpeng.2017.01.019.
- Sauer, C.; Heine, A.; Riedel, W.; Wickert, M. (2017): Application of the RHT concrete model for predictive simulations of the penetration into adobe targets. In: S. Chocron und J. Walker (Hg.): *Proceedings, Vol. 2. 30th International Symposium on Ballistics*. Long Beach, CA, USA, 11.–15.9.2017. Lancaster, PA, USA: DEStech Publications, S. 2093–2104.
- Sauer, C.; Heine, A.; Weber, K. E.; Riedel, W. (2017): Stability of tungsten projectiles penetrating adobe masonry - Combined experimental and numerical analysis. In: *International Journal of Impact Engineering* 109, S. 67–77. DOI: 10.1016/j.ijimpeng.2017.06.001.
- Schimmerohn, M.; Watson, E.; Gulde, M.; Kortmann, L.; Schäfer, F. (2018): Measuring ejecta characteristics and momentum transfer in experimental simulation of kinetic impact. In: *Acta Astronautica*. DOI: 10.1016/j.actaastro.2018.01.046.
- Spagnuolo, M.; Barcz, K.; Pfaff, A.; dell’Isola, F.; Franciosi, P. (2017): Qualitative pivot damage analysis in aluminum printed pantographic sheets – Numerics and experiments. In: *Mechanics Research Communications* 83, S. 47–52. DOI: 10.1016/j.mechrescom.2017.05.005.
- Steinhauser, M.; Schindler, T. (2017): Particle-based simulations of bilayer membranes. Self-assembly, structural analysis, and shock-wave damage. In: *Computational Particle Mechanics* 4 (1), S. 69–86. DOI: 10.1007/s40571-016-0126-3.
- Steinhauser, M.; Watson, E. (2017): Discrete particle methods for simulating quasi-static load and hypervelocity impact phenomena. In: *International Journal of Computational Methods* 86, S. 1740009. DOI: 10.1142/S0219876217400096.
- Stolz, A.; Ramin, M. von; Schmitt, D. (2018): Protection of buildings and infrastructure against explosion. In: K. Tsuji (Hg.): *The Micro-World Observed by Ultra High-Speed Cameras. We See What You Don’t See*. Cham: Springer, S. 279–302.
- Straßburger, E.; Bauer, S. (2017): Analysis of the interaction of projectiles with ceramic targets by means of flash X-ray cinematography and optical methods. In: *Proceedings of the 41st International Conference on Advanced Ceramics and Composites: Ceramic Engineering and Science Proceedings*. Daytona Beach, FL, USA, 22.–27.1.2017.
- Van der Werff, H.; Heisserer, U.; Coussens, B.; Stepanyan, R.; Riedel, W.; Laessig, T. (2017): On the ultimate potential of high strength polymeric fibers to reduce armor weight. In: S. Chocron und J. Walker (Hg.): *Proceedings, Vol. 2. 30th International Symposium on Ballistics*. Long Beach, CA, USA, 11.–15.9.2017. Lancaster, PA, USA: DEStech Publications, S. 1863–1875.
- Vincke, J.; Kempf, S.; Schnelle, N.; Horch, C.; Schäfer, F. (2017): A concept for an ultra-low power sensor network – Detecting and monitoring disaster events in underground metro systems. In: *Proceedings of the 6th International Conference on Sensor Networks (SENSORNETS)*. Porto, Portugal, 19.–21.2.2017, S. 150–155.
- Vincke, J.; Kempf, S.; Schnelle, N.; Horch, C.; Schäfer, F. (2017): Ultra-low power sensor system for disaster event detection in metro tunnel systems. In: *Sensors & Transducers* 212 (5), S. 15–22. Online verfügbar unter http://www.sensorsportal.com/HTML/DIGEST/may_2017/Vol_212/P_2923.pdf.
- Watson, E.; Gulde, M.; Hiermaier, S. (2017): Fragment tracking in hypervelocity impact experiments. In: *Procedia Engineering* 204, S. 170–177. DOI: 10.1016/j.proeng.2017.09.770.
- Watson, E.; Steinhauser, M. (2017): Discrete particle method for simulating hypervelocity impact phenomena. In: *Materials* 10 (4), S. Art. 379. DOI: 10.3390/ma10040379.
- Watson, E.; Steinhauser, M. (2017): Simulating hypervelocity impact phenomena with discrete elements. In: *Procedia Engineering* 204, S. 75–82. DOI: 10.1016/j.proeng.2017.09.728.
- Wolf, S.; Kiessling, J.; Kunz, M.; Popko, G.; Buse, K.; Kühnemann, F. (2017): Upconversion-enabled array spectrometer for the mid-infrared, featuring kilohertz spectra acquisition rates. In: *Optics Express* 25 (13), S. 14504–14515. DOI: 10.1364/OE.25.014504.
- Zwiessler, R.; Kenkmann, T.; Poelchau, M. H.; Nau, S.; Hess, S. (2017): On the use of a split Hopkinson pressure bar in structural geology. High strain rate deformation of Seeberger sandstone and Carrara marble under uniaxial compression. In: *Journal of Structural Geology* 97, S. 225–236. DOI: 10.1016/j.jsg.2017.03.007.

Publications in books, specialist journals and proceedings without peer review

- Bierdel, M.; Hoschke, K.; Pfaff, A.; Jäcklein, M.; Schimmerohn, M.; Wickert, M. (2017): Multidisciplinary design optimization of a satellite structure by additive manufacturing. In: Proceedings of the 68th International Astronautical Congress (IAC). Adelaide, Australia, 25.–29.9.2017.
- D'Haen, J. A.; Kilchert, S.; Knoll, O.; May, M.; Hiermaier, S. (2017): Progressive failure strain measurement of a compression loaded carbon fiber laminate. In: Proceedings of the 21st International Conference on Composite Materials (ICCM-21). Xi'an, China, 20.–25.8.2017.
- Finger, J.; Faist, K.; Hasenstein, S.; Leismann, T. (2017): Analyse von Kaskadeneffekten in Versorgungsnetzen. Softwaretool CAESAR (Cascading Effect Simulation in Urban Areas to Assess and Increase Resilience). In: Transforming Cities 2 (4), S. 58–60.
- Grunwald, C.; Lässig, T.; van der Werff, H.; Heisserer, U.; Nguyen, L.; Riedel, W. (2017): Numerical sensitivity study of ballistic impact on UHMWPE composites. In: Proceedings of the 6th International Conference on Design and Analysis of Protective Structures (DAPS) 2017. Melbourne, Australia, 29.11.–1.12.2017.
- Grunwald, C.; Schaufelberger, B.; Riedel, W. (2017): Numerical modeling of the shock response and failure of concrete – Comparing the RHT model in ANSYS Autodyn and LS-DYNA. In: Proceedings of the 17th International Symposium on the Interaction of the Effects of Munitions with Structures (17th ISIEMS). Bad Neuenahr, 16.–20.10.2017.
- Gulde, M.; Kortmann, L.; Watson, E.; Ebert, M.; Schäfer, F. (2017): High-speed optical tracking of individual ejecta particles from hypervelocity impacts. In: Proceedings of the 48th Lunar and Planetary Science Conference. The Woodlands, TX, USA, 20.–24.3.2017. Online verfügbar unter <http://www.lpi.usra.edu/meetings/lpsc2017/pdf/1925.pdf>.
- Gulde, M.; Sido, A.; Pielok, M.; Hoschke, K.; Schäfer, F.; Schimmerohn, M. (2017): Managing high thermal loads in small satellites – Analysis, design, and verification of a 3D-printed radiator. In: Proceedings of the 68th International Astronautical Congress (IAC). Adelaide, Australia, 25.–29.9.2017.
- Hiermaier, S.; Gebbeken, N.; Klaus, M.; Stolz, A. (Hg.) (2017): 7. Workshop BAU-PROTECT. Gefährdung, dynamische Analyse und Schutzkonzepte für bauliche Strukturen. Tagungsband. Freiburg, 15.–16.11.2016. Stuttgart: Fraunhofer Verlag.
- Higashide, M.; Schimmerohn, M.; Schäfer, F. (2017): Initial study on non-catastrophic damage risk for all-electric satellite transferring to GEO. In: Proceedings of the 68th International Astronautical Congress (IAC). Adelaide, Australia, 25.–29.9.2017.
- Horch, C.; Schnelle, N.; Gulde, M.; Watson, E.; Schimmerohn, M.; Schäfer, F. (2017): An MWIR payload with FPGA-based data processing for a 12U nanosatellite. In: Proceedings of the 11th IAA Symposium on Small Satellites for Earth Observation. Berlin, 24.–28.4.2017.
- Hoschke, K.; Bierdel, M. (2017): Topology and shape optimization with hybrid CAD design for additive manufacturing. In: NAFEMS Benchmark Magazine (7).
- Hoschke, K.; Pfaff, A. (2017): Bionic wheel carrier of electric vehicle. In: Design for Additive Manufacturing. Guidelines and Case Studies for Metal Applications, S. 29–44. Online verfügbar unter http://canadamakes.ca/wp-content/uploads/2017/05/2017-05-15_Industry-Canada_Design4AM_141283.pdf.
- Léost, Y.; Sonntag, A.; Haase, T. (2017): Modeling of a cast aluminum wheel for crash application. In: Proceedings of the 11th European LS-DYNA Conference. Salzburg, Austria, 9.–11.5.2017, S. 1–10.
- May, M.; Harper, P.; Hallet, S. (2017): A study on the influence of fatigue damage initiation laws for cohesive zone models in propagation-driven load cases. In: Proceedings of the 58th AIAA/ASCE/AHS/ASC Structures, Structural Dynamics, and Materials Conference, AIAA SciTech Forum. Grapevine, TX, USA, 9.–13.1.2017.
- Pope, D.; Dirlwanger, H.; Russell, D.; Landmann, F.; Habacker, C.; Barr, A.; Tyas, A.; Stolz, A. (2017): Enhancement of HESCO-bastion wall models to better predict magnitudes of response under far-field loading conditions. In: Proceedings of the 17th International Symposium on the Effects of Munitions with Structures (ISIEMS). Bad Neuenahr, 16.–20.10.2017.
- Ramin, M. von; Stolz, A. (2017): Damage classification for buildings subjected to extreme loading. In: Proceedings of the 17th International Symposium on the Effects of Munitions with Structures (ISIEMS). Bad Neuenahr, 16.–20.10.2017.
- Riedel, W.; Klomfass, A.; Rüdiger, L.; Gündisch, R. (2017): Effiziente Methoden zur Auslegung und Bewertung baulicher Strukturen in der Vorplanung. In: S. Hiermaier, N. Gebbeken, M. Klaus und A. Stolz (Hg.): 7. Workshop BAU-PROTECT. Gefährdung, dynamische Analyse und Schutzkonzepte für bauliche Strukturen. Tagungsband. Freiburg, 15.–16.11.2016. Stuttgart: Fraunhofer Verlag, S. 175–192.
- Sandoval Murillo, J. L.; Ganzenmüller, G. C. (2017): Convergence analysis of the Affine Particle-In-Cell method and its application to the simulation of extrusion processes. In: Proceedings of the V. International Conference on Particle-Based Methods: Fundamentals and Applications. Hannover, 26.–28.9.2017, S. 397–408.
- Sauer, C.; Heine, A.; Riedel, W. (2017): Numerical simulation of adobe targets perforated by WHA-projectiles. In: Proceedings of the 17th International Symposium on the Interaction of the Effects of Munitions with Structures (17th ISIEMS). Bad Neuenahr, 16.–20.10.2017.
- Schaufelberger, B.; Roller, C.; Riedel, W. (2017): Scaling rules for the analysis of blast loaded concrete structures – a critical literature review. In: Proceedings of the 6th International Conference on Design and Analysis of Protective Structures (DAPS) 2017. Melbourne, Australia, 29.11.–1.12.2017.
- Schimmerohn, M.; Watson, E.; Hupfer, J.; Pfaff, A.; Falke, A.; Schäfer, F. (2017): The D-MEN sampling device – Extracting and collecting asteroid material for sample return. In: Proceedings of the 68th International Astronautical Congress (IAC). Adelaide, Australia, 25.–29.9.2017.
- Sinn, T.; Reichenbach, N.; Schimmerohn, M.; Horch, C.; Seefeldt, P. (2017): The development of a passive de-orbit subsystem for small and micro satellites. In: Proceedings of the 68th International Astronautical Congress (IAC). Adelaide, Australia, 25.–29.9.2017.
- Watson, E.; Gulde, M.; Schäfer, F.; Hiermaier, S. (2017): Optical fragment tracking in hypervelocity impact experiments. In: Proceedings of the 68th International Astronautical Congress (IAC). Adelaide, Australia, 25.–29.9.2017.
- Weerheijm, J.; Grunwald, C.; Ramin, M. von; Slobbe, A. T. (2017): An integral modelling approach for the loading and break-up of RC structures due to internal explosion of fragmenting shells. In: Proceedings of the 17th International Symposium on the Effects of Munitions with Structures (ISIEMS). Bad Neuenahr, 16.–20.10.2017.

SCIENTIFIC EXCHANGE, LECTURES

Lectures at congresses, symposia, colloquia, external seminars and important working conferences

- Behner, T.; Heine, A.; Wickert, M. (2017): Extended investigation of the dwell effect for an unconfined silicon carbide ceramic against tungsten-heavy-alloy rods. 30th International Symposium on Ballistics. Long Beach, CA, USA, 12.9.2017.
- Bierdel, M. (2017): Ressourceneffizienz wie in der Natur durch intelligentes Leichtbaudesign für den Herstellungsprozess der Additiven Fertigung. 4. Technologietag Hybrider Leichtbau. Stuttgart, 30.5.2017.
- Bierdel, M.; Hoschke, K. (2017): Multidisciplinary design optimization of a satellite structure by Additive Manufacturing. 12th World Congress of Structural and Multidisciplinary Optimisation. Braunschweig, 7.6.2017.
- Denefeld, V. (2017): Measurement of the spatial specific impulse distribution due to buried high explosive charge detonation. 30th International Symposium on Ballistics. Long Beach, CA, USA, 13.9.2017.
- Denefeld, V.; Heider, N. (2017): Einfluss der Verlegebedingungen auf die Impulsverteilung bei IED-Ansprengungen. 21. Tagung "Schutz gegen IED und ballistische Bedrohung". Meppen, 14.11.2017.
- Denefeld, V.; Heider, N.; Holzwarth, A. (2017): Bestimmung der Impulsverteilung bei IED-Ansprengungen in Sandy Gravel. 20. Tagung "Schutz gegen IED und ballistische Bedrohung". Meppen, 30.5.2017.
- D'Haen, J. A.; Kerscher, S.; May, M.; Hiermaier, S. (2017): Analysis of failure modes of multi directional carbon fiber composites loaded in compression. 6th Thematic Conference on the Mechanical Response of Composites (COMPOSITES 2017). Eindhoven, The Netherlands, 20.9.2017.
- Durr, N.; Isakov, M.; Sauer, M. (2017): Mechanical characterization of HTPB – Current status and material models update. CMME-Treffen. Washington DC, USA, 28.11.2017.
- Durr, N.; Sauer, M. (2017): Mesoscale material models update. CMME-Treffen. Fraunhofer ICT. Pfinztal, 16.5.2017.
- Durr, N.; Sauer, M.; Hiermaier, S. (2017): Mesoscale modeling of dynamic fracture in quartzite and sandstone and homogenization to macroscale. CFRAC 2017. Nantes, France, 14.6.2017.
- Ebenhöch, S.; Kanat, B.; Häring, I.; Stolz, A. (2017): Erstellung von symptom-basierten Fehlersuchanleitungen für Elektrofahrzeuge mittels Fehlerbaumanalyse. Praxisforum Fehlerbaumanalyse & Co. München, 17.10.2017.
- Ebenhöch, S.; Kanat, B.; Scheidereiter, J.; Grumber, C.; Stolz, A. (2017): Sicherheitsnachweise von "Smart Systems" – Herausforderungen und neue Konzepte. microTEC Südwest Clusterkonferenz. Freiburg, 27.3.2017.
- Ebenhöch, S.; Scheidereiter, J.; Lang, B.; Nau, S.; Stolz, A. (2017): Challenges for the use of logic devices in the implementation of safety features for fuzing systems. 60th Fuze Conference. Cincinnati, OH, USA, 9.5.2017.
- Ebenhöch, S.; Siebold, U.; Grumber, C.; Scheidereiter, J.; Stolz, A. (2017): Sicherheitsnachweise für vernetzte intelligente Systeme – Neue Methoden und Forschungsansätze. safe.tech. München, 25.4.2017.
- Früh, P.; Heine, A.; Riedel, W.; Wickert, M. (2017): Protection capabilities of HHA and UHA steels against long-rod kinetic energy penetrators. 30th International Symposium on Ballistics. Long Beach, CA, USA, 14.9.2017.
- Früh P.; Heine A.; Riedel W. (2017): Assessment of the protective properties of two different UHA steels based on material testing and numerical simulation. International Conference on Dynamic Fracture of Ductile Materials. Trondheim, Norway, 12.9.2017.
- Grunwald, C.; Lässig, T.; van der Werff, H.; Heisserer, U.; Nguyen, L.; Riedel, W. (2017): Numerical sensitivity study of ballistic impact on UHMWPE composites. 6th International Conference on Design and Analysis of Protective Structures (DAPS). Melbourne, Australia, 30.11.2017.
- Grunwald, C.; Schaufelberger, B.; Riedel, W. (2017): Numerical modeling of the shock response and failure of concrete – Comparing the RHT model in ANSYS Autodyn and LS-DYNA. 17th International Symposium on the Effects of Munitions with Structures (ISIEMS). Bad Neuenahr, 16.10.2017.
- Gulde, M. (2017): High-speed optical tracking of individual ejecta particles from hypervelocity impacts. 48th Lunar and Planetary Science Conference. The Woodlands, TX, USA, 23.3.2017.
- Gulde, M. (2017): Time-resolved investigation of hypervelocity impacts. Museum für Naturkunde. Berlin, 18.5.2017.
- Gulde, M. (2017): Managing high thermal loads in small satellites – Analysis, design, and verification of a 3D-printed radiator. 68th International Astronautical Congress (IAC). Adelaide, Australia, 28.9.2017.
- Heine, A. (2017): Current results obtained within work package 3b of the IABG subcontract. DEU-NLD-USA Workshop on Weapon Effects with Respect to MOUT. Ottobrunn, 19.6.2017.
- Heine, A.; Früh, P.; Riedel, W. (2017): Assessment of the protective properties of two different UHA steels based on material testing and numerical simulation. DYMAT 23rd Technical Meeting: Dynamic Fracture of Ductile Materials. Trondheim, Norway, 12.9.2017.
- Hiermaier, S. (2017): Experten-Statement: Naturkatastrophen – Terrorismus – Cybersicherheit: Keynote: "Resilience Engineering: Ein neues Konzept für mehr Sicherheit". Morgenradar. Bundestag Berlin, 15.2.2017.
- Hiermaier, S. (2017): Keynote: "Resiliente Systeme in der Wehrtechnik – ein neuer Ingenieur-Ansatz". Symposium Ergebnisse der grundfinanzierten Forschung. Bildungszentrum der Bundeswehr (BIZBw). Mannheim, 20.2.2017.
- Hiermaier, S. (2017): Resilience Engineering – From Concepts to Applications. Risk Center Seminar Series. ETH Zürich, 16.5.2017.
- Hiermaier, S. (2017): Resilienz als neuen Ansatz für Sicherheit. Workshop "Forum Spezial: Cyberintervention". Zukunftsforum Öffentliche Sicherheit e.V. Berlin, 18.5.2017.
- Hiermaier, S. (2017): Applying engineering methods for resilient design. Resilience Symposium. Lüttich, Belgien, 28.6.2017.
- Hiermaier, S. (2017): Keynote: "Resilience quantification for developing socio cyber technical systems". Acatech – Themennetzwerk Sicherheit IOSB. Fraunhofer IOSB, Karlsruhe, 20.7.2017.
- Hiermaier, S.; Neuhaus, G. (2017): Keynote: "Resilienz für Industrie 4.0 – eine wichtige Voraussetzung für das Gelingen der vierten industriellen Revolution". Parlamentarisches Frühstück. Alte Kanzlei, Stuttgart, 5.4.2017.
- Hoschke, K. (2017): Additives Materialdesign für Leichtbau. Fraunhofer-Alumni-Summit 2017. Stuttgart, 24.11.2017.

- Hoschke, K.; Bierdel, M. (2017): Robust design optimization with metamaterial by Additive Manufacturing. 12th World Congress of Structural and Multidisciplinary Optimisation. Braunschweig, 8.6.2017.
- Leismann, T. (2017): Industrie 4.0 – Vision, Chancen und Herausforderungen. Workshop Hannover Re, Hannover, 21.2.2017.
- Leismann, T. (2017): Sichere Gesellschaften: Gestaltung des zukünftigen Europäischen Sicherheitsprogramms. Moderation Panel und Vortrag zu "Perspective of academic and institutional research on shaping the future Security Research Programme". BMBF Workshop. Brüssel, 21.11.2017.
- Leismann, T. (2017): Resilienzmanagement der vernetzten Infrastruktur. 2. Jahrestagung Business Continuity & Resilience Management. Berlin, 26.9.2017.
- Leismann, T.; Feese, J. (2017): Tech Center i-protect – Nachhaltige Lösungen für die integrale Sicherheit der Mobilität der Zukunft. Industriewoche Sparkasse Kajo. Freiburg, 21.6.2017.
- Lück, M. (2017): Grundlagen eines Hydrocodes – Kontinuumsmechanik, Materialtheorie und numerische Implementierung. Doktorandenseminar von Prof. Dr. rer. nat. Wolfgang H. Müller, Fachgebiet Kontinuumsmechanik und Materialtheorie, Institut für Mechanik, TU Berlin. Berlin, 20.1.2017.
- May, M.; Lässig, T. (2017): Modeling of delamination in UHMW-PE composites. 6th Thematic Conference on the Mechanical Response of Composites (COMPOSITES 2017). Eindhoven, The Netherlands, 21.9.2017.
- Moser, S.; Hofstätter, M. (2017): DURCHBLICK – Detektion unterschiedlicher unkonventioneller Spreng- und Brandvorrichtungen mittels intelligenter analytischer Sensoren. Auftaktveranstaltung "Aspekte und Maßnahmen der Terrorismusbekämpfung" des BMBF. Berlin, 2.5.2017.
- Nickl, S.; Gulde, M. (2017): Zeitaufgelöste Messung von Kraterwachstum bei Hypervelocity Impacts. 66. Deutscher Luft- und Raumfahrt Kongress. München, 6.9.2017.
- Paul, H.; Ledford, N.; Sauer, M.; May, M.; Okamura, M. (2017): Assessment of test methods for thick and thin layer adhesive joints under high rates of loading. 4th International Conference on Structural Adhesive Bonding (AB 2017). Porto, Portugal, 6.7.2017.
- Pfaff, A. (2017): Manufacturing strategy and heat treatment of a slender, second gradient material structure in AlSi10Mg by Selective Laser Melting. Euromech Colloquium 579. Arpino, Italy, 6.4.2017.
- Pfaff, A. (2017): Innovative materials by Additive Manufacturing – Design and characterization of AlSi10Mg processed by Selective Laser Melting. Werkstoffwoche. Dresden, 26.9.2017.
- Pfaff, A.; Jäcklein, M.; Hoschke, K.; Wickert, M. (2017): Designed Materials by Additive Manufacturing – impact of exposure-strategies and -parameters on material characteristics of AlSi10Mg processed by Selective Laser Melting. LightMAT 2017. Bremen, 9.11.2017.
- Pfaff, A.; Wickert, M. (2017): Additive Manufacturing – Praxis des 3D-Drucks großer Metallbauteile. WVIB-Akademie: Infoveranstaltung – Schnelle Teile aus der 3D-Fabrik. Baden-Baden, 25.7.2017.
- Ramin, M. von; Stolz, A. (2017): Structural robustness and its implications for resilient designs. 7th REA Symposium. Resilience Engineering Association. Liège, Belgium, 26.6.2017.
- Ramin, M. von; Stottmeister, A. (2017): On lung injury models for risk analyses of complex blast scenarios. 19th International Physical Security Forum IPSF. Stockholm, Sweden, 7.5.2017.
- Sandoval Murillo, J. L. (2017): Accuracy and convergence behavior of the Affine-Particle-In-Cell-Method. 9th International Workshop Meshfree Methods for Partial Differential Equations. Bonn, 18.9.2017.
- Sättler, A.; Aurich, H.; Holzwarth, A. (2017): HL-Beschuss von Treibladungspulvern. 18. Arbeitskreis Innenballistik. Fraunhofer ICT. Pfinztal, 18.10.2017.
- Sauer, C.; Heine, A.; Riedel, W.; Wickert, M. (2017): Development and application of a hydrocode model for the penetration into adobe masonry. DEU-NLD-USA Workshop on Weapon Effects with Respect to MOUT. Ottobrunn, 19.6.2017.
- Sauer, C.; Heine, A.; Riedel, W.; Wickert, M. (2017): Application of the RHT concrete model for predictive simulations of the penetration into adobe targets. 30th International Symposium on Ballistics. Long Beach, CA, USA, 13.9.2017.
- Sauer, C.; Heine, A.; Wickert, M. (2017): Numerical simulations of adobe targets perforated by WHA-projectiles. 17th International Symposium on the Effects of Munitions with Structures (SIEMS). Bad Neuenahr, Germany, 16.10.2017.
- Sauer, M.; Durr, N. (2017): Current status of meso-mechanical simulation methods and application to PBX. CMME-Treffen. Fraunhofer ICT. Pfinztal, 16.5.2017.
- Sauer, M.; Durr, N. (2017): Current status of meso-mechanical simulation methods in SOPHIA and application to PBX. CMME-Treffen. Washington DC, USA, 28.11.2017.
- Sauer, M.; Kölbl, F.; Mattiasson, K.; Carlberger, T.; Pipkorn, B.; Ottosen, P.; Ericsson, J.; Sjögren, T.; Karlsson, J.; Schmidt, L.; Wenig, S.; Jergeus, J.; Buckley, M. (2017): Validation tests and simulations for laminated safety glass. European LS-DYNA Conference. Salzburg, Austria, 11.5.2017.
- Sauer, M.; Kölbl, F.; Mattiasson, K.; Carlberger, T.; Pipkorn, B.; Ottosen, P.; Ericsson, J.; Sjögren, T.; Karlsson, J.; Schmidt, L.; Wenig, S.; Jergeus, J.; Buckley, M. (2017): Validation tests and simulations for laminated safety glass. LS-DYNA and JSTAMP Forum. Tokyo, Japan, 31.10.2017.
- Schauflberger, B.; Matura, P. (2017): Modellierung von Schmelzbränden mittels Pyrolyse mit FDS. 11. Anwendertreffen der FDS Usergroup. Berlin, 9.11.2017.
- Schauflberger, B.; Roller, C.; Riedel, W. (2017): Scaling rules for the analysis of blast loaded concrete structures – a critical literature review. 6th International Conference on Design and Analysis of Protective Structures (DAPS). Melbourne, Australia, 29.11.2017.
- Schmitt, D.; Dirlwanger, H.; Stolz, A.; Schopferer, S.; Nau, S. (2017): Investigations on reinforced concrete slabs under impact of mortar tail units. 17th International Symposium on the Effects of Munitions with Structures (SIEMS). Bad Neuenahr, 16.10.2017.
- Sido, A.; Gulde, M. (2017): Eine für Kleinstsatelliten angepasste Methode zur Thermalanalyse. 66. Deutscher Luft- und Raumfahrt-Kongress. München, 6.9.2017.
- Straßburger, E.; Bauer, S. (2017): Analysis of the interaction of projectiles with ceramic targets by means of flash X-ray cinematography and optical methods. 41st International Conference on Advanced Ceramics and Composites. Daytona Beach, FL, USA, 22.1.2017.

Straßburger, E.; Bauer, S. (2017): Untersuchungen zur Effizienz von Spinell-Keramik gegen AP-Munition. 20. Tagung "Schutz gegen IED und ballistische Bedrohung". Meppen, 30.5.2017.

Straßburger, E.; Bauer, S. (2017): Vergleich der Effizienz transparenter Keramiken gegen AP-Munition. 21. Tagung "Schutz gegen IED und ballistische Bedrohung". Meppen, 14.11.2017.

Van der Werff, H.; Heisserer, U.; Coussens, B.; Stepanyan, R.; Riedel, W.; Lässig, T. (2017): On the ultimate potential of high strength polymeric fibers to reduce armor weight, Keynote contribution. 30th International Symposium on Ballistics. Long Beach, CA, USA, 11.9.2017.

Weerheijm, J.; Grunwald, C.; Riedel, W.; Ramin, M. von; Slobbe, A. T. (2017): An integral modelling approach for the loading and breakup of RC structures due to internal explosion of fragmenting shells. 17th International Symposium on the Effects of Munitions with Structures (ISIEMS). Bad Neuenahr, 16.10.2017.

Seminar lectures at EMI

Durr, N. (2017): Mesoscale modeling of dynamic fracture in quartzite and sandstone. EMI-Doktorandenseminar. EMI Freiburg, 24.2.2017.

Durr, N. (2017): Mesoscale modeling of dynamic fracture and shock compression in quartzite and sandstone. Disputationsvortrag. Freiburg, 22.5.2017.

Ebenhöch, S.; Niklas, W.; Osterholz, J. (2017): Probabilistic laser safety risk evaluation and modeling. Workshop AFRL – German MoD. EMI Freiburg, 19.9.2017.

Hoschke, K. (2017): Additive Design and Manufacturing – 3D-Druck von Strukturmaterialien und intelligentes Design für Leichtbau und Kurzzzeitdynamik. 43. Kuratoriumssitzung. EMI Freiburg, 21.7.2017.

Hoschke, K. (2017): 3D-Druckzentrum Metall- und Strukturwerkstoffe. EMI-Symposium. EMI Freiburg, 6.12.2017.

Lück, M. (2017): Beschreibung des Reaktionsablaufs energetischer Materialien bei Laserbestrahlung. Probevortrag für Disputation. EMI-Doktorandenseminar. EMI Freiburg, 28.7.2017.

Lück, M. (2017): Time-to-Explosion: Simulationsmodell für die Laserwirkung auf Ziele mit energetischen Materialien. EMI-Symposium. EMI Freiburg, 6.12.2017.

Osterholz, J. (2017): Wirken mit Licht: Das neue Labor für Hochenergielaser und Lasertechnologie. EMI-Jahressymposium. EMI Freiburg, 6.12.2017.

Pfaff, A. (2017): Designed Materials by Additive Manufacturing – Approaches towards functionally designed microstructures. EMI-Doktorandenseminar. EMI Freiburg, 21.1.2017.

Sättler, A.; van Keuk, J.; Thoma, O.; Dutschke, B.; Dolak, M. (2017): Herausforderungen der Innen- und Abgangsbalistik bei Großkaliber-Systemen. EMI-Symposium. EMI Freiburg, 6.12.2017.

Straßburger, E. (2017): Quo Vadis Leichter Schutz? EMI-Symposium, 6.12.2017.

Courses of the Carl-Craz-Gesellschaft

Ebenhöch, S. (2017): Funktionaler Sicherheitsnachweis für vernetzte wehrtechnische Systeme unter Berücksichtigung der Datensicherheit. CCG-Seminar VS 1.53 "Funktionaler Sicherheitsnachweis für wehrtechnische Systeme". EMI Efringen-Kirchen, 4.4.2017.

Ebenhöch, S. (2017): Methoden und Werkzeuge für die Entwicklung und den Sicherheitsnachweis von modernen wehrtechnischen Systemen. CCG-Seminar VS 1.53 "Funktionaler Sicherheitsnachweis für wehrtechnische Systeme". EMI Efringen-Kirchen, 4.4.2017.

Niklas, W.; Ebenhöch, S.; Engelmann, F. (2017): Anwendungsbeispiele zur quantitativen Gefährdungs- und Risikoanalyse zur Festlegung von Gesamtsicherheitsanforderungen. CCG-Seminar VS 1.53 "Funktionaler Sicherheitsnachweis für wehrtechnische Systeme". EMI Freiburg, 4.4.2017.

Straßburger, E. (2017): Röntgenblitzkinematografie in der Endballistik. CCG-Seminar VS 3.02 "Ballistische Messtechnik und experimentelle Verfahren". ISL. Saint-Louis, 8.3.2017.

Straßburger, E. (2017): Endballistik kleinkalibriger Geschosse – Keramik für den ballistischen Schutz. CCG-Seminar VS 1.43 "Endballistik – Grundlagen und Anwendungen". ISL. Saint-Louis, 27.6.2017.

Courses of the Bildungszentrum der Bundeswehr, Mannheim

Aurich, H.; Sättler, A. (2017): Initiierung von insensitiver Munition durch IED-EFP-Beschuss. Symposium Ergebnisse der grundfinanzierten Forschung: "Explosivstoffe, Energiespeicher, Lenkflugkörper, Wirkung und Schutz". Bildungszentrum der Bundeswehr (BiZBw). Mannheim, 20.2.2017.

Bagusat, F.; Harwick, W. (2017): Probenminiaturisierung zur Erweiterung hochdynamischer Untersuchungsmöglichkeiten von Schweißnähten. Symposium Ergebnisse der grundfinanzierten Forschung: "Explosivstoffe, Energiespeicher, Lenkflugkörper, Wirkung und Schutz". Bildungszentrum der Bundeswehr (BiZBw). Mannheim, 20.2.2017.

Ebenhöch, S.; Niklas, W.; Engelmann, F.; Schäfer, J.; Ramin, M. von; Häring, I.; Stolz, A. (2017): Quantitative Risikoanalyse – Methodik und Anwendungsbeispiele. Kurzlehrgang: Besonderheiten im Projektmanagement bei der Beschaffung von Waffensystemen und Munition. BAANBw Koblenz, 28.9.2017.

Ebenhöch, S.; Niklas, W.; Engelmann, F.; Schäfer, J.; Ramin, M. von; Siebold, U.; Häring, I.; Stolz, A. (2017): Quantitative Risikoanalyse – Methodik und Anwendungsbeispiele. Kurzlehrgang: Besonderheiten im Projektmanagement bei der Beschaffung von Waffensystemen und Munition. BAANBw Koblenz, 30.3.2017.

Ebenhöch, S.; Niklas, W.; Engelmann, F.; Siebold, U.; Häring, I.; Stolz, A. (2017): Risiko- und Sicherheitsanalysen für vernetzte Waffensysteme – Herausforderungen und neue Forschungsansätze. Symposium Ergebnisse der grundfinanzierten Forschung: "Explosivstoffe, Energiespeicher, Lenkflugkörper, Wirkung und Schutz". Bildungszentrum der Bundeswehr (BiZBw). Mannheim, 20.2.2017.

Hoschke, K.; Wickert, M. (2017): Additive Design and Manufacturing. Symposium Ergebnisse der grundfinanzierten Forschung: "Explosivstoffe, Energiespeicher, Lenkflugkörper, Wirkung und Schutz". Mannheim, 21.2.2017.

Ramin, M. von (2017): Gesamtschadensklassifizierung von Gebäuden nach Explosionsereignissen. Symposium Ergebnisse der grundfinanzierten Forschung: "Explosivstoffe, Energiespeicher, Lenkflugkörper, Wirkung und Schutz", 20.2.2017.

Sauer, C.; Heine, A.; Riedel, W.; Wickert, M. (2017): Materialmodell für die numerische Simulation der Geschosswirkung bei Lehmziegelwänden. Symposium Ergebnisse der grundfinanzierten Forschung: "Explosivstoffe, Energiespeicher, Lenkflugkörper, Wirkung und Schutz", 20.2.2017.

Lectures

Gulde, M.: "Shock Waves in Rocks" – Assistenz bei Blockveranstaltung von Frank Schäfer an der Uni Freiburg.

Gulde, M.: "Shocked Materials" – Assistenz bei Blockveranstaltung von Frank Schäfer an der Uni Freiburg.

Häring, I. (Sommersemester 2017): Functional Safety: Active Resilience. Vorlesung. Albert-Ludwigs-Universität Freiburg.

Häring, I. (Sommersemester 2017): Risk Analysis. Certificate of Advanced Studies (CAS), Blended-Learning Kurs von Fraunhofer EMI in Zusammenarbeit mit Universität Freiburg und Fraunhofer Academy; zertifiziert durch ACQUIN. Albert-Ludwigs-Universität Freiburg.

Häring, I. (Sommersemester 2017): Technical Safety. Certificate of Advanced Studies (CAS), Blended-Learning Kurs von Fraunhofer EMI in Zusammenarbeit mit Universität Freiburg und Fraunhofer Academy; zertifiziert durch ACQUIN. Albert-Ludwigs-Universität Freiburg.

Häring, I.; Gelhausen, P. (Sommersemester 2017): Resilience Analysis. Certificate of Advanced Studies (CAS), Blended-Learning Kurs von Fraunhofer EMI in Zusammenarbeit mit Universität Freiburg und Fraunhofer Academy; zertifiziert durch ACQUIN. Albert-Ludwigs-Universität Freiburg.

Harwick, W. (Sommersemester 2017): Werkstoffkunde I. Vorlesung. DHBW Lörrach.

Harwick, W. (Wintersemester 2017/2018): Werkstoffkunde II. Vorlesung. DHBW Lörrach.

Hiermaier, S. (Sommersemester 2017): Dynamics of Materials. Vorlesung. Albert-Ludwigs-Universität Freiburg.

Hiermaier, S. (Wintersemester 2017/2018): Keynote: "Resilient Infrastructures – From Concepts to Application". Gastvorlesung. Stevens Institute of Technology, Hoboken, New York, 23.10.2017.

Hiermaier, S. (Wintersemester 2017/2018): Keynote: "The Resilient City – Managing Stocks and Disruption". Gastvorlesung. German Center for Research and Innovation, New York, 24.10.2017.

Hiermaier, S. (Wintersemester 2017/2018): Resilient Infrastructures – From Concepts to Application. Gastvorlesung. GRI Seminar Space. NEU, Boston, 26.10.2017.

Hiermaier, S.; Ganzenmüller, G. C. (Sommersemester 2017): Particle Methods in Engineering. Vorlesung und Übung. Albert-Ludwigs-Universität Freiburg.

Hiermaier, S.; Ganzenmüller, G. C. (Wintersemester 2017/2018): Physics of Failure. Vorlesung. Albert-Ludwigs-Universität Freiburg.

Hiermaier, S.; Kilchert, S. (Wintersemester 2017/2018): Material Life Cycles. Vorlesung und Übung. Albert-Ludwigs-Universität Freiburg.

Hiermaier, S.; May, M. (Sommersemester 2017): Dynamics of Materials. Vorlesung und Übung. Albert-Ludwigs-Universität Freiburg.

Hiermaier, S.; Scharke, B. (Wintersemester 2017/2018): Fundamentals of Resilience. Vorlesung und Übung. Albert-Ludwigs-Universität Freiburg.

Matura, P. (Wintersemester 2017/2018): Numerische Methoden in der Mathematik. Vorlesung. DHBW Lörrach.

Osterholz, J. (Wintersemester 2017/2018): High Energy Density Physics. Vorlesung. Heinrich-Heine-Universität Düsseldorf.

Riedel, W. (Sommersemester 2017): Dynamic Material Behaviour – Part I: Testing at Highest Rates and Theory. Übung an der Nanyang Technological University, School of Civil and Environmental Engineering, Protection Technology and Research Center, Singapore.

Riedel, W. (Sommersemester 2017): Dynamic Material Behaviour – Part II: Simulation of Metals, Concrete and Composites. Übung an der Nanyang Technological University, School of Civil and Environmental Engineering, Protection Technology and Research Center, Singapore.

Riedel, W. (Sommersemester 2017): From Protection of Built Infrastructure to Urban Security and Resilience. Vorlesung an der Nanyang Technological University, School of Civil and Environmental Engineering, Protection Technology and Research Center, Singapore.

Riedel, W. (Wintersemester 2017/2018): Schutz kritischer Infrastrukturen. Vorlesung im Mastermodul "Quantitative Risikoanalyse" im Studiengang "Security and Safety Engineering". HFU Furtwangen University.

Riedel, W.; Häring, I.; Gelhausen, P. (Sommersemester 2017): Structural Security. Certificate of Advanced Studies (CAS), Blended-Learning Kurs von Fraunhofer EMI in Zusammenarbeit mit Universität Freiburg und Fraunhofer Academy; zertifiziert durch ACQUIN. Albert-Ludwigs-Universität Freiburg.

Sauer, M. (Wintersemester 2017/2018): Finite Methoden und Stoffgesetze Hochdynamik. Universität der Bundeswehr München.

Schäfer, F. (Sommersemester 2017): Characterization of Geomaterials under Shock Loads I. Vorlesung und Übung. Albert-Ludwigs-Universität Freiburg.

Schäfer, F. (Sommersemester 2017): Characterization of Geomaterials under Shock Loads II. Vorlesung und Übung. Albert-Ludwigs-Universität Freiburg.

Schäfer, F. (Wintersemester 2017/2018): Shock Waves in Rocks I. Vorlesung. Albert-Ludwigs-Universität Freiburg.

Steinhaus, M. (Sommersemester 2017): Advanced Methods in Computational Sciences: Monte Carlo Simulations. Vorlesung. Universität Basel.

Steinhaus, M. (Sommersemester 2017): Molecular Dynamics Simulations with Applications in Soft Matter. Vorlesung. Universität Basel.

Stolz, A. (Sommersemester 2017): Baudynamik. Vorlesung. Hochschule Koblenz.

Stolz, A. (Sommersemester 2017): Design and Monitoring of Large Urban Infrastructures. Vorlesung. Albert-Ludwigs-Universität Freiburg.

Stolz, A. (Wintersemester 2017/2018): Structural Robustness: Resilient Designs. Vorlesung. Albert-Ludwigs-Universität Freiburg.

Weidemaier, P. (Wintersemester 2017/2018): Differentialgleichungen für Studierende der Mikrosystemtechnik. Vorlesung und Übung. Albert-Ludwigs-Universität Freiburg.

Visiting Scientists at EMI

Gary Goh Wen Xian, Defence Science & Technology Agency – DSTA Singapore, 9.–27.10.2017.

Kok Wei Kang, Defence Science & Technology Agency – DSTA Singapore, 9.–27.10.2017.

Lai Liyue, Defence Science & Technology Agency – DSTA Singapore, 9.–27.10.2017.

Masumi Higashide, Japan Aerospace Exploration Agency – JAXA, 1.11.2016–31.10.2017.

PhD

Andricevic, N. (2016): Robustheitsbewertung crashbelasteter Fahrzeugstrukturen. Dissertation. Albert-Ludwigs-Universität Freiburg.

Dlugosch, M. (2018): Zur Methodenentwicklung im Entwurf automobiler Strukturkonzepte in FVK-Metall-Hybridbauweise unter Crashbelastung. Dissertation. Albert-Ludwigs-Universität Freiburg.

Durr, N. (2017): Mesoscale Modeling of Dynamic Fracture and Shock Compression in Quartzite and Sandstone. Dissertation. Albert-Ludwigs-Universität Freiburg.

Fischer, K. (2018): Resilience quantification of urban areas – An integrated statistical-empirical-physical approach for man-made and natural disruptive events. Dissertation. Albert-Ludwigs-Universität Freiburg.

Lässig, T. (2017): Einfluss des Pressdrucks auf UHMW-PE-Verbundmaterialien unter Impaktbelastung. Dissertation. Universität der Bundeswehr München.

Lück, M. (2017): Beschreibung des Reaktionsablaufs energetischer Materialien bei Laserbestrahlung. Dissertation. TU Berlin. DOI: 10.14279/depositon-6407.

Wagner, P. (2017): A Methodology for Numerical Fatigue Analysis of Carbon Fiber Reinforced Plastics. Dissertation. Albert-Ludwigs-Universität Freiburg.

Bachelor, Master and Diploma theses

Becher, T. (2017): Historical data-driven risk and resilience analysis for selected natural threats. Masterarbeit. EMI-Bericht E 26/17. HFU Furtwangen.

Berger, H. (2018): Stereoskopische Analyse von Raumfahrzeugoberflächen zur Kraterdetektion. Bachelorarbeit. EMI-Bericht A 09/18. HFU Furtwangen.

Fulari, G. S. (2017): Complexity and sensitivity studies for modeling FRP-metal hybrid material systems under crash loading in generic automotive structures. Masterarbeit. TU Braunschweig.

Greiner, J. (2017): Konzeption und Implementierung einer 3D-Rendering-Engine und einer 3D-Anwendungsbibliothek mit C# unter .NET als Ersatz für eine bestehende Programmbibliothek. Bachelorarbeit. EMI-Bericht A 15/17. DHBW Lörrach.

Grittmann, J. (2018): Modellbasierte Entwicklung und Aufbau eines Vibrations-Piezo-Harvesters im Gleisbett. Masterarbeit. EMI-Bericht A 10/18. FH Aachen.

Huber, C. (2017): Periodische Homogenisierung einer linear-elastischen Platte am Beispiel eines mehrschichtigen Akkus. Masterarbeit. Albert-Ludwigs-Universität Freiburg.

Kopitzka, N. (2017): Design einer Rezeptur und experimentelle Untersuchungen zum dynamischen Widerstandsverhalten von "Engineered Cementitious Composites (ECC)". Bachelorarbeit. EMI-Bericht A 43/16. HFU Furtwangen.

Lange, J. (2018): Numerische Modellierung von Hagelschlag auf Flugzeugstrukturen. Masterarbeit. EMI-Bericht A 17/18. TU Braunschweig.

Mäder, G. (2018): Nichtlineare Analyse und Designoptimierung von Messtrukturen für die Additive Fertigung. Masterarbeit. EMI-Bericht A 05/18. Universität Stuttgart.

Mahlke, M. (2017): Bewertung von Optimierungsmöglichkeiten einer Treibkäfigauslegung zur Beschleunigung von Laborpenetratoren mit einem Leichtgas-Experimentalbeschleuniger. Bachelorarbeit. EMI-Bericht A 24/17. Duale Hochschule Baden-Württemberg, Mannheim.

Moser, D. (2017): Bestimmung von Werkstoffkennwerten und Charakterisierung der Materialzonen einer Stahl-Schweißverbindung. Bachelorarbeit. EMI-Bericht A 19/17. DHBW Lörrach.

Nickl, S. (2017): Zeitaufgelöste Messung von Kraterwachstum bei Hypervelocity Impacts. Bachelorarbeit. EMI-Bericht A 22/17. Hochschule Karlsruhe Technik und Wirtschaft.

Nothdurft, S. (2018): Entwurf und Realisierung eines Steuerungskonzepts für ein quasistatisches Materialprüfungssystem mit in-situ-Computertomographie. Bachelorarbeit. EMI-Bericht A 08/18. Hochschule Esslingen.

Pielok, M. (2017): Auslegung passiver Thermalkontrollkomponenten für Kleinstsatelliten mit Hilfe additiver Fertigung – Multidisziplinäre Topologieoptimierung und makroskopische Oberflächenstrukturierung. Bachelorarbeit. EMI-Bericht A 17/17. Westfälische Hochschule.

Reichenbach, N. (2018): Development of a De-Orbit Subsystem for the 12U-CubeSat ERNST. Masterarbeit. EMI-Bericht A 01/18. TU München.

Roth, S. (2017): Entwicklung eines kompakten Mechanismus zum Wechsel optischer Filter für die Anwendung in Nanosatelliten. Masterarbeit. EMI-Bericht A 16/17. Hochschule Offenburg.

Schramm, M. (2017): Konzipierung und Anwendungsbewertung strukturierter SLM-Materialien. Bachelorarbeit. EMI-Bericht A 30/17. Westfälische Hochschule.

Sido, A. (2017): Eine für Kleinstsatelliten angepasste Methode zur Thermalanalyse. Masterarbeit. EMI-Bericht A 06/17. Albert-Ludwigs-Universität Freiburg.

Sikora, G. (2017): Erweiterung einer Prüfvorrichtung für Mikrozugversuche. Bachelorarbeit. EMI-Bericht A 20/17. DHBW Lörrach.

Socha, F. (2017): Quantification of the resilience of socio-technical systems: graph, probabilistic and Markov models. Masterarbeit. EMI-Bericht A 25/17. HFU Furtwangen.

Soot, T. (2017): Mechanismen der Energieabsorption in FVK-Metall-Hybridstrukturen unter Biegebelastung. Masterarbeit. EMI-Bericht A 07/17. Karlsruher Institut für Technologie (KIT).

Spiegelhalter, B. (2017): Experimentelle Untersuchungen des Crashverhaltens von generischen Fahrzeugstrukturen in FVK-Metall-Hybridbauweise. Masterarbeit. EMI-Bericht A 11/17. HFU Furtwangen.

Sterk, F. (2017): Methodik zur computergestützten Entwicklung eines Flugzeugbauteils für die Herstellung durch Additive Fertigung. Bachelorarbeit. EMI-Bericht A 23/17. Technische Hochschule Nürnberg.

Patents

Heine, A.; Wickert, M.; Thoma, K. (2008): Hohlladung am 9.10.2008. Anmelden: 08017755.3. Veröffentlichungsnr: EP 2 053 341 B1.

Publication series of Fraunhofer EMI

Andricevic, N. (2017): Robustheitsbewertung crashbelasteter Fahrzeugstrukturen. Stuttgart: Fraunhofer Verlag (Schriftenreihe des Ernst-Mach-Instituts (Epsilon-Punkt), Heft Nr. 31).

Bach, A. (2017): Stahlbetonbauteile unter kombinierten statischen und detonativen Belastungen in Experiment, Simulation und Bemessung. Stuttgart: Fraunhofer Verlag (Schriftenreihe des Ernst-Mach-Instituts (Epsilon-Punkt), Heft Nr. 29).

Moser, S. (2017): Computertomographie mit stark unterbestimmten Datensätzen für komplexe Anwendungen. Stuttgart: Fraunhofer Verlag (Schriftenreihe des Ernst-Mach-Instituts (Epsilon-Punkt), Heft Nr. 30).

Workshops and events

Seminar der Carl-Cranz-Gesellschaft "Funktionaler Sicherheitsnachweis für wehrtechnische Systeme", CCG-Seminar VS 1.53, 4.-5.4.2017. EMI Efringen-Kirchen.

International Workshop on Metamaterial and Realization by 3D-Printing (2017). Freiburg, 26.1.2017.

Participation in professional boards, associations and program committees

Gulde, M.: Dworknik Judge auf der LPSC 2017.

Gulde, M.: Review für ACS Applied Nano Materials.

Gulde, M.: Review für Acta Astronautica.

Günther, S.: Institutsleitungsrat (ILR) der Fraunhofer-Gesellschaft für Clean Sky 2 (Vertretung von S. Hiermaier).

Günther, S.: Mitglied im Technischen Rat Fraunhofer-Gesellschaft für Clean Sky 2.

Günther, S.: Mitglied in WG 4 Safety and Security in ACARE (Advisory Council for Aeronautics Research in Europe).

Günther, S.: Steering Committee Clean Sky 2 Airframe für die Fraunhofer-Gesellschaft.

Heine, A.: Paper Selection Committee, 30th International Symposium on Ballistics.

Matura, P.: Mitglied im Educational Outreach Committee der Hypervelocity Impact Society (HVIS).

May, M.: Fraunhofer-Vertreter im Project Management Committee des JTI Clean Sky 2, Airframe ITD.

May, M.: Mitglied im Scientific Committee der Fachtagung "6th ECCOMAS Thematic Conference on the Mechanical Response of Composites – Composites 2017" in Eindhoven, NL.

May, M.: Stellvertretender Fraunhofer-Vertreter im Steering Committee des JTI Clean Sky 2, Airframe ITD.

May, M.: Stellvertretender Fraunhofer-VVS-Vertreter im Bereich Future Combat Aircraft System.

Paul, H.: Mitglied in der Arbeitsgruppe Composite Engineer der Fraunhofer-Personenzertifizierungsstelle.

Pilous, N.; Ebenhöch, S.: DIN-Normenausschuss: Elektromagnetische Verträglichkeit (EMV); EMV von Anzünd- und Zündmitteln (NA 140-00-20-06 UA).

Putzar, R.: Chairman der Aeroballistics Range Association.

Putzar, R.: Mitglied des Committee on the Review of Planetary Protection Requirements for Sample Return from Phobos and Deimos des Space Studies Board der The National Academies of Sciences Engineering Medicine.

Putzar, R.: Repräsentant des EMI bei der Aeroballistics Range Association.

Ramin, M. von: Mitglied beim American Concrete Institute (ACI).

Ramin, M. von: Mitglied beim Deutschen Ausschuss für Stahlbeton (DAfStb).

Sättler, A.: CapTech Non-Governmental Expert im CapTech Ammunition der EDA.

Sättler, A.: Leitung der Taskforce Innenballistik-Simulation.

Sättler, A.: Mitglied im Arbeitskreis Außenballistik.

Sättler, A.: Mitglied im Arbeitskreis Innenballistik.

Stolz, A.: International member ABR10 Committee on Critical Infrastructure Protection im Transport Research Board TRB.

Stolz, A.: Koordinator "Resistance of structures to explosion effects" im Rahmen des ERNCIP (European Reference network for Critical Infrastructure protection) framework.

Evaluated excellent research – projects funded by the German Research Foundation (DFG), the German Federal Ministry of Education and Research (BMBF) or the European Research Council

DURCHBLICK: Detektion unterschiedlicher unkonventioneller Spreng- und Brandvorrichtungen mittels intelligenter analytischer Sensorik. BMBF-gefördertes Projekt. Online verfügbar unter <http://www.durchblick-projekt.de/>.

GAS-O-CHROM Gasochrome Sensoren – Optische Gassensoren für den Einsatz in Brandmeldern zur Brandgasfrüherkennung. BMBF-gefördertes Projekt. Online verfügbar unter https://www.sifo.de/files/Projektumriss_GAS-O-CHROM.pdf.

MEMIN II: Multidisciplinary Experimental and Modeling Impact Research Network, Projekt 1, "Investigation of the transient early-stage physical processes of hypervelocity impacts into solid target rocks". DFG-gefördertes Projekt. Online verfügbar unter http://www.memin.de/project_II.html.

PROMPT: Programmatische Auswahl von Sofortmaßnahmen für die Einsatzdisposition bei Großschadensereignissen. BMBF-gefördertes Projekt. Online verfügbar unter https://www.sifo.de/files/Projektumriss_PROMPT.pdf.

SenSE4Metro: Sicherheitsmanagement- und Notfalleinsatzsystem für U-Bahn-Systeme. BMBF-gefördertes Projekt. Online verfügbar unter <http://www.sense4metro.org/>.

TAURUS: Transatlantic initiative to increase the visibility of German system solutions for urban resilience and security. BMBF-gefördertes Projekt. Online verfügbar unter <https://www.research-in-germany.org/shaping-the-future/research-networks/taurus.html>.

PUBLISHING NOTES

Editors

Birgit Bindnagel (responsible), Heide Haasdonk

Editorial assistance

Raffaella Grimm, Johanna Holz, Katrina-Magdalena Lindemann, Eerika Tzschoppe

Layout and graphics

Deborah Kabel, Sonja Weber

Photo editorial department

Birgit Bindnagel, Heide Haasdonk

Published by

Fraunhofer Institute for High-Speed Dynamics, Ernst-Mach-Institut, EMI
Press and Public Relations
Ernst-Zermelo-Strasse 4
79104 Freiburg, Germany
Phone +49 761 2714-366
birgit.bindnagel@emi.fraunhofer.de
www.emi.fraunhofer.de

© Fraunhofer EMI, Freiburg 2018

Printed by

Fraunhofer Verlag
Printed on FSC certified paper made from renewable resources.





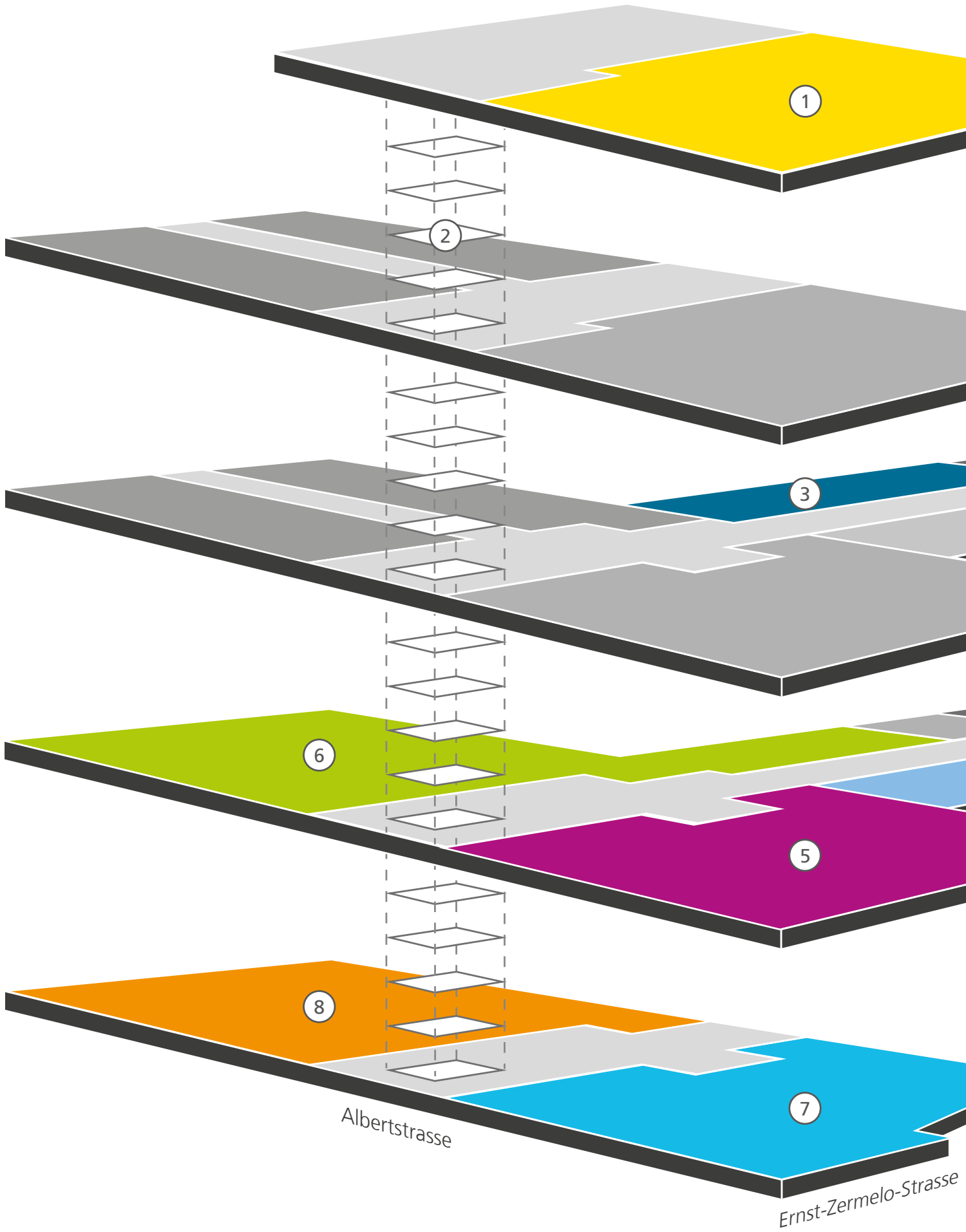

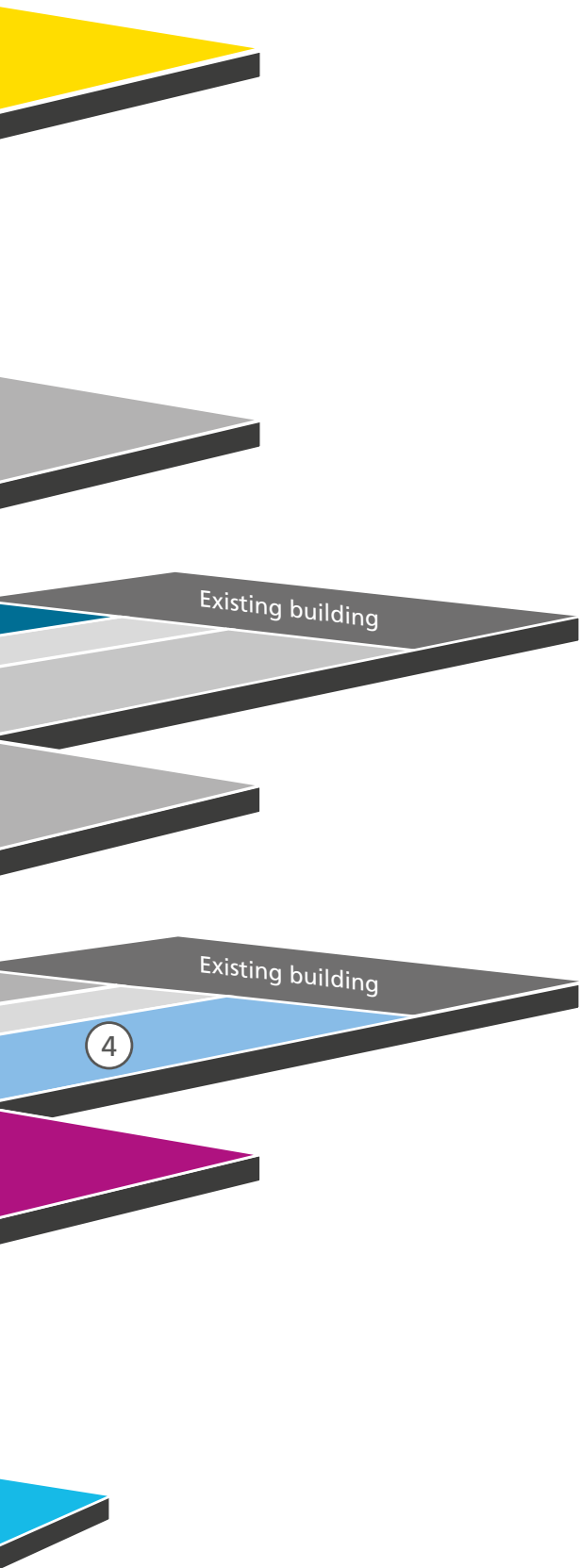

① Management of the institute

② Art in architecture

③ Library

④ Satellite Lab

⑤ Sensor Lab

⑥ Laser Technology Lab

⑦ 3D-Printing Lab Metals
and Structural Materials

⑧ Multi-Material Design Lab

Fraunhofer Institute for High-Speed Dynamics,
Ernst-Mach-Institut, EMI
Ernst-Zermelo-Strasse 4
79104 Freiburg, Germany
Phone +49 761 2714-0
info@emi.fraunhofer.de
www.emi.fraunhofer.de

Locations

Freiburg, Efringen-Kirchen and Kandern